PORTAUTENSILI PSC ISO

AMPIA GAMMA DI PORTAUTENSILI
PSC PER VARIE APPLICAZIONI



*M*plus...

PORTAUTENSILI PSC ISO

AMPIA GAMMA DI PORTAUTENSILI PSC PER VARIE APPLICAZIONI

La nuova serie di portautensili ISO PSC si avvale delle più recenti tecnologie, materiali e geometrie. Grazie all'ampia varietà di utensili disponibili, questa serie offre una soluzione per quasi tutte le applicazioni, da quelle multiuso a quelle di tornitura, fresatura e profilatura, fino alle barre di alesatura.

GAMMA DI PRODOTTI

- Portautensile di tipo D
- Portautensili di tipo P
- Portautensile di tipo S
- Barra per alesatura di tipo P
- Barra per alesatura di tipo S
- Filettatura esterna e interna
- Portautensile con bloccaggio a staffa per inserti in ceramica

DISPONIBILITÀ

- Tutte le applicazioni di tornitura

CARATTERISTICHE

- Elevata resistenza alla rottura
- Taglio stabile e prevenzione di bave
- Passaggio interno del lubrorefrigerante
- Bloccaggio sicuro dell'inserto
- Corpo estremamente resistente all'usura



OTTIMIZZAZIONE DELLA DURATA UTENSILE

MIGLIORE FINITURA DELLE SUPERFICI

MAGGIORE AFFIDABILITÀ DI PROCESSO

AUMENTO DELLA PRODUTTIVITÀ



VANTAGGI

- Ottimizzazione della durata utensile
- Migliore finitura delle superfici
- Maggiore affidabilità di processo
- Aumento della produttività



PORTAUTENSILI PSC ISO

Portautensili ISO PSC con passaggio del refrigerante ottimizzato sul tagliente, per una lunga vita utensile e un'ottima evacuazione del truciolo.



Bloccaggio sicuro.

Materiale e rivestimento del corpo dell'utensile ad elevata resistenza per una lunga durata del portautensile.

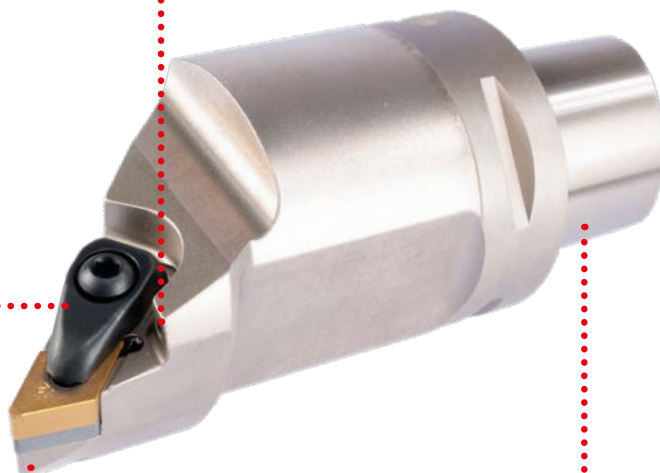
La forma poligonale del portautensile PSC garantisce un bloccaggio stabile, un perfetto posizionamento e previene giochi torsionali e flessioni.



INDICE

Codice prodotto		Codice prodotto	
DCKN 75°	4	SDJC 93°	26
DCLN 95°	5	SDNC 62° 30`	27
DCMN 50°	7	SVHC 107° 30`	28
DCRN 75°	8	SVJC 93°	29
DDHN 107° 30`	9	SVVC 72° 30`	30
DDJN 93°	10	PCLN 95°	31
DDMN 48°	11	PDUN 93°	33
DSDN 45°	12	SCLC 95°	35
DSSN 45°	13	SDUC 93°	37
DVJN 93°	14	SVQC 107° 30`	39
DVVN 72° 30`	15	Filettatura esterna 90°	40
DWLN 95°	16	Filettatura interna 90°	41
PCLN 95°	17	CRSN	45
PCRN 75°	19	Adattatore attacco tipo MA (manicotto)	46
PDJN 93°	20	Adattatore attacco tipo MS (avvitato metrico)	47
PSDN 45°	21	Adattatore attacco tipo B (barenatura interna)	48
PSKN 75°	22	Adattatore attacco tipo C (porta pinza erc)	50
PSRN 75°	23	Adattatore tipo TA (stelo quadro assiale)	52
PSSN 45°	24	Adattatore tipo TR (stelo quadro radiale)	53
SCLC 95°	25	Tappo psc tipo AC	54

NOTE: Ci riserviamo il diritto di apportare modifiche alle informazioni e illustrazioni inerenti a qualsiasi articolo del presente catalogo (ad esempio i dati tecnici, la costruzione, l'equipaggiamento fornito, il materiale e l'aspetto esterno).

È possibile visualizzare l'ultima versione di questo catalogo sul nostro microsito: www.mmc-hardmetal.com

DCKN 75°

PORTAUTENSILE MULTIFUNZIONALE EQUIPAGGIATO CON INSERTI BILATERALI NEGATIVI A FORMA ROMBICA





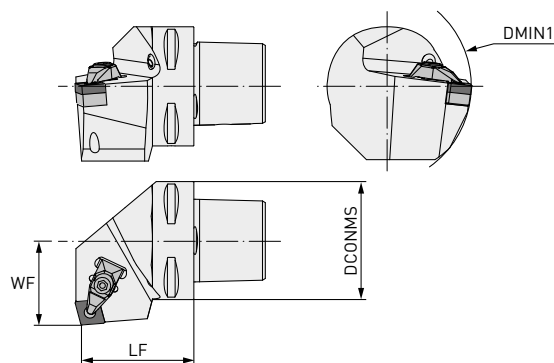



GAMF: -6°
GAMP: -6°



Codice ordinazione	Disponibilità	Direzione	DCONMS	DMIN1	LF	WF	WT	Inserto
PSC40-DCKNL27050-12	☐	L	40	110	50	27	0.42	
PSC40-DCKNR27050-12	●	R	40	110	50	27	0.42	
PSC50-DCKNL35060-12	☐	L	50	110	60	35	0.80	CN00120400
PSC50-DCKNR35060-12	☐	R	50	110	60	35	0.80	
PSC63-DCKNL45065-12	☐	L	63	110	65	45	1.10	
PSC63-DCKNR45065-12	☐	R	63	110	65	45	1.10	
PSC63-DCKNL45065-16	●	L	63	125	65	45	1.10	CN00160600
PSC63-DCKNR45065-16	●	R	63	125	65	45	1.10	
PSC80-DCKNL55080-19	●	L	80	125	80	55	2.74	CN00190600
PSC80-DCKNR55080-19	●	R	80	125	80	55	2.74	

RICAMBI

Codice utensile						
PSC40-DCKNL27050-12	MP1766	MPICSN-442	MP2712			
PSC40-DCKNR27050-12	MP1766	MPICSN-442	MP2712			
PSC50-DCKNL35060-12	MP1766	MPICSN-442	MP2712			
PSC50-DCKNR35060-12	MP1766	MPICSN-442	MP2712			
PSC63-DCKNL45065-12	MP1766	MPICSN-442	MP2712			
PSC63-DCKNR45065-12	MP1766	MPICSN-442	MP2712	MP1696	MP4295	MP5004
PSC63-DCKNL45065-16	MP1768	MPICSN-533	MP2716			
PSC63-DCKNR45065-16	MP1768	MPICSN-533	MP2716			
PSC80-DCKNL55080-19	MP1770	MPICSN-633	MP2719			
PSC80-DCKNR55080-19	MP1770	MPICSN-633	MP2719			

DCLN 95°

PORTAUTENSILE MULTIFUNZIONALE EQUIPAGGIATO CON INSERTI BILATERALI NEGATIVI A FORMA ROMBICA





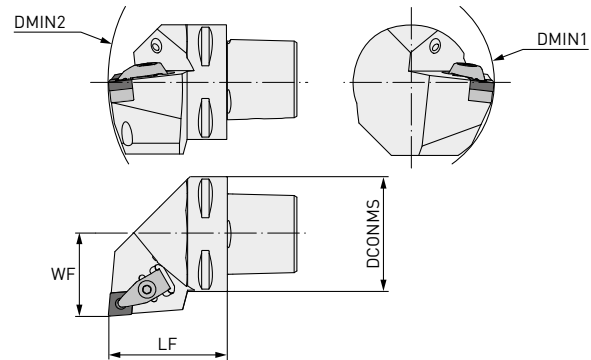



GAMF: -6°
GAMP: -6°



Codice ordinazione	Disponibilità	Direzione	DCONMS	DMIN1	DMIN2	LF	WF	WT	Inserto
PSC40-DCLNL27050-12	●	L	40	110	140	50	27	0.42	CN00120400
PSC40-DCLNR27050-12	●	R	40	110	110	50	27	0.42	
PSC50-DCLNL35060-12	●	L	50	110	165	60	35	0.80	
PSC50-DCLNR35060-12	●	R	50	110	165	60	35	0.80	
PSC63-DCLNL45065-12	●	L	63	110	190	65	45	1.10	
PSC63-DCLNR45065-12	●	R	63	110	190	65	45	1.10	
PSC80-DCLNL55080-12	●	L	80	110	250	80	55	2.74	
PSC80-DCLNR55080-12	●	R	80	110	250	80	55	2.74	
PSC50-DCLNL35060-16	●	L	50	125	165	60	35	0.80	CN00160600
PSC50-DCLNR35060-16	●	R	50	125	165	60	35	0.80	
PSC63-DCLNL45065-16	●	L	63	125	190	65	45	1.10	
PSC63-DCLNR45065-16	●	R	63	125	190	65	45	1.10	
PSC80-DCLNL55080-16	●	L	80	125	250	80	55	2.74	CN00190600
PSC80-DCLNR55080-16	●	R	80	125	250	80	55	2.74	
PSC63-DCLNL45065-19	●	L	63	125	190	65	45	1.10	
PSC63-DCLNR45065-19	●	R	63	125	190	65	45	1.10	
PSC80-DCLNL55080-19	●	L	80	125	250	80	55	2.74	CN00190600
PSC80-DCLNR55080-19	●	R	80	125	250	80	55	2.74	

RICAMBI

Codice utensile						
PSC40-DCLNL27050-12	MP1766	MPICSN-442	MP2712			
PSC40-DCLNR27050-12	MP1766	MPICSN-442	MP2712			
PSC50-DCLNL35060-12	MP1766	MPICSN-442	MP2712			
PSC50-DCLNR35060-12	MP1766	MPICSN-442	MP2712			
PSC63-DCLNL45065-12	MP1766	MPICSN-442	MP2712			
PSC63-DCLNR45065-12	MP1766	MPICSN-442	MP2712			
PSC80-DCLNL55080-12	MP1766	MPICSN-442	MP2712			
PSC80-DCLNR55080-12	MP1766	MPICSN-442	MP2712			
PSC50-DCLNL35060-16	MP1768	MPICSN-533	MP2716	MP1696	MP4295	MP5004
PSC50-DCLNR35060-16	MP1768	MPICSN-533	MP2716			
PSC63-DCLNL45065-16	MP1768	MPICSN-533	MP2716			
PSC63-DCLNR45065-16	MP1768	MPICSN-533	MP2716			
PSC80-DCLNL55080-16	MP1768	MPICSN-533	MP2716			
PSC80-DCLNR55080-16	MP1768	MPICSN-533	MP2716			
PSC63-DCLNL45065-19	MP1770	MPICSN-633	MP2719			
PSC63-DCLNR45065-19	MP1770	MPICSN-633	MP2719			
PSC80-DCLNL55080-19	MP1770	MPICSN-633	MP2719			
PSC80-DCLNR55080-19	MP1770	MPICSN-633	MP2719			

DCMNN 50°

PORTAUTENSILE MULTIFUNZIONALE EQUIPAGGIATO CON INSERTI BILATERALI NEGATIVI A FORMA ROMBICA





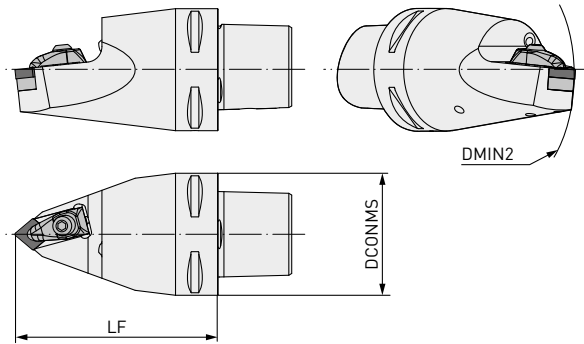



GAMF: -6°
GAMP: -6°



Codice ordinazione	Disponibilità	DCONMS	DMIN2	LF	WT	Inserto
PSC63-DCMNN00115-12	●	63	110	115	1.7	CN00120400
PSC80-DCMNN00150-16	●	80	115	150	3.3	CN00160600

RICAMBI

Codice utensile						
PSC63-DCMNN00115-12	MP1766	MPICSN-442	MP2712	MP1696	MP4295	MP5004
PSC80-DCMNN00150-16	MP1768	MPICSN-533	MP2716			

DCRN 75°

PORTAUTENSILE MULTIFUNZIONALE EQUIPAGGIATO CON INSERTI BILATERALI NEGATIVI A FORMA ROMBICA





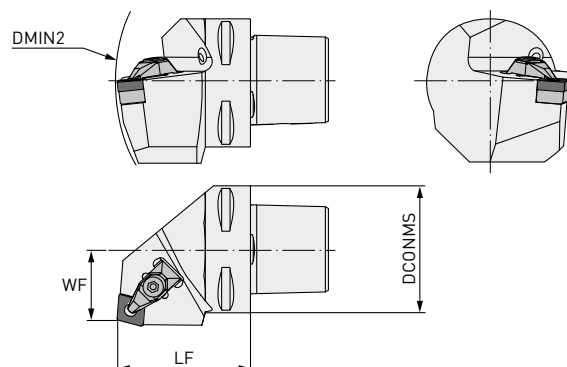



GAMF: -6°
GAMP: -6°



Codice ordinazione	Disponibilità	Direzione	DCON	DMIN2	WF	LF	WT	Inserto
PSC50-DCRNL27060-12	<input type="checkbox"/>	L	50	165	27	60	0.80	CN00120400
PSC50-DCRNR27060-12	<input type="checkbox"/>	R	50	165	27	60	0.80	
PSC63-DCRNL35065-12	<input type="checkbox"/>	L	63	190	35	65	1.40	CN00160600
PSC63-DCRNR35065-12	<input type="checkbox"/>	R	63	190	35	65	1.40	
PSC63-DCRNL35065-16	<input checked="" type="checkbox"/>	L	63	190	35	65	1.40	CN00190600
PSC63-DCRNR35065-16	<input type="checkbox"/>	R	63	190	35	65	1.40	
PSC80-DCRNL55080-16	<input checked="" type="checkbox"/>	L	80	250	55	80	2.74	CN00190600
PSC80-DCRNR55080-16	<input type="checkbox"/>	R	80	250	55	80	2.74	
PSC63-DCRNL35065-19	<input checked="" type="checkbox"/>	L	63	190	35	65	1.40	CN00190600
PSC63-DCRNR35065-19	<input checked="" type="checkbox"/>	R	63	190	35	65	1.40	
PSC80-DCRNL55080-19	<input checked="" type="checkbox"/>	L	80	250	55	80	2.74	
PSC80-DCRNR55080-19	<input checked="" type="checkbox"/>	R	80	250	55	80	2.74	

RICAMBI

Codice utensile						
PSC50-DCRNL27060-12	MP1766	MPICSN-442	MP2712			
PSC50-DCRNR27060-12	MP1766	MPICSN-442	MP2712			
PSC63-DCRNL35065-12	MP1766	MPICSN-442	MP2712			
PSC63-DCRNR35065-12	MP1766	MPICSN-442	MP2712			
PSC63-DCRNL35065-16	MP1768	MPICSN-533	MP2716			
PSC63-DCRNR35065-16	MP1768	MPICSN-533	MP2716			
PSC80-DCRNL55080-16	MP1768	MPICSN-533	MP2716	MP1696	MP4295	MP5004
PSC80-DCRNR55080-16	MP1768	MPICSN-533	MP2716			
PSC63-DCRNL35065-19	MP1770	MPICSN-633	MP2719			
PSC63-DCRNR35065-19	MP1770	MPICSN-633	MP2719			
PSC80-DCRNL55080-19	MP1770	MPICSN-633	MP2719			
PSC80-DCRNR55080-19	MP1770	MPICSN-633	MP2719			

DDHN 107° 30'

PORTAUTENSILE PER TORNITURA E PROFILATURA EQUIPAGGIATO CON INSERTI BILATERALI NEGATIVI A FORMA ROMBICA





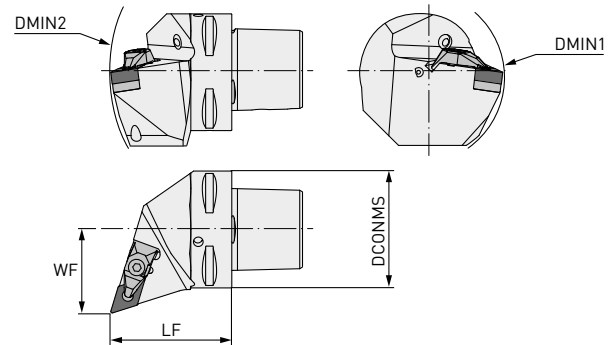



GAMF: -6°
GAMP: -7°



Codice ordinazione	Disponibilità	Direzione	DCONMS	DMIN1	DMIN2	WF	LF	WT	Inserto
PSC40-DDHNL27055-15	●	L	40	110	145	27	55	0.43	DN00150600
PSC40-DDHNR27055-15	□	R	40	110	145	27	55	0.43	
PSC50-DDHNL35060-15	●	L	50	110	165	35	60	0.80	
PSC50-DDHNR35060-15	●	R	50	110	165	35	60	0.80	
PSC63-DDHNL45065-15	●	L	63	110	190	45	65	1.10	
PSC63-DDHNR45065-15	●	R	63	110	190	45	65	1.10	
PSC80-DDHNL55080-15	●	L	80	110	250	55	80	2.74	
PSC80-DDHNR55080-15	●	R	80	110	250	55	80	2.74	

RICAMBI

Codice utensile						
PSC40-DDHNL27055-15						
PSC40-DDHNR27055-15						
PSC50-DDHNL35060-15						
PSC50-DDHNR35060-15	MP1766	MPIDSN-432	MP2712	MP1696	MP4295	MP5004
PSC63-DDHNL45065-15						
PSC63-DDHNR45065-15						
PSC80-DDHNL55080-15						
PSC80-DDHNR55080-15						

DDJN 93°

PORTAUTENSILE PER TORNITURA E PROFILATURA EQUIPAGGIATO CON INSERTI BILATERALI NEGATIVI A FORMA ROMBICA





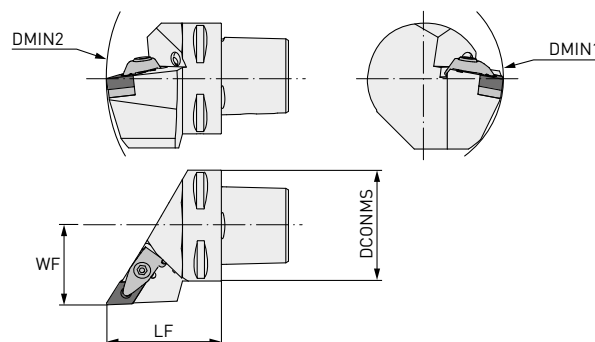



GAMF: -6°
GAMP: -7°



Codice ordinazione	Disponibilità	Direzione	DCON	DMIN1	DMIN2	WF	LF	WT	Inserto
PSC40-DDJNL27050-11	●	L	40	60	140	27	50	0.42	DN \odot 1104 $\odot\odot$
PSC40-DDJNR27050-11	●	R	40	60	140	27	50	0.42	
PSC40-DDJNL27055-15	●	L	40	110	145	27	55	0.42	DN \odot 1506 $\odot\odot$
PSC40-DDJNR27055-15	●	R	40	110	145	27	55	1.10	
PSC50-DDJNL35060-11	●	L	50	65	165	35	60	0.80	DN \odot 1104 $\odot\odot$
PSC50-DDJNR35060-11	●	R	50	65	165	35	60	0.80	
PSC50-DDJNL35060-15	●	L	50	110	165	35	60	0.80	
PSC50-DDJNR35060-15	●	R	50	110	165	35	60	0.80	
PSC63-DDJNL45065-15	●	L	63	110	190	45	65	1.10	DN \odot 1506 $\odot\odot$
PSC63-DDJNR45065-15	●	R	63	110	190	45	65	1.10	
PSC80-DDJNL55080-15	●	L	80	110	250	55	80	2.74	
PSC80-DDJNR55080-15	●	R	80	110	250	55	80	2.74	

RICAMBI

Codice utensile						
PSC40-DDJNL27050-11	MP1764	MPIDSN-322	MP2708	MP1695	MP4294	
PSC40-DDJNR27050-11	MP1764	MPIDSN-322	MP2708	MP1695	MP4294	
PSC40-DDJNL27055-15	MP1766	MPIDSN-432	MP2712	MP1696	MP4295	
PSC40-DDJNR27055-15	MP1766	MPIDSN-432	MP2712	MP1696	MP4295	
PSC50-DDJNL35060-11	MP1764	MPIDSN-322	MP2708	MP1695	MP4294	
PSC50-DDJNR35060-11	MP1764	MPIDSN-322	MP2708	MP1695	MP4294	
PSC50-DDJNL35060-15	MP1766	MPIDSN-432	MP2712	MP1696	MP4295	MP5004
PSC50-DDJNR35060-15	MP1766	MPIDSN-432	MP2712	MP1696	MP4295	
PSC63-DDJNL45065-15	MP1766	MPIDSN-432	MP2712	MP1696	MP4295	
PSC63-DDJNR45065-15	MP1766	MPIDSN-432	MP2712	MP1696	MP4295	
PSC80-DDJNL55080-15	MP1766	MPIDSN-432	MP2712	MP1696	MP4295	
PSC80-DDJNR55080-15	MP1766	MPIDSN-432	MP2712	MP1696	MP4295	

DDMN 48°

PORTAUTENSILE MULTIFUNZIONALE EQUIPAGGIATO CON INSERTI BILATERALI NEGATIVI A FORMA ROMBICA





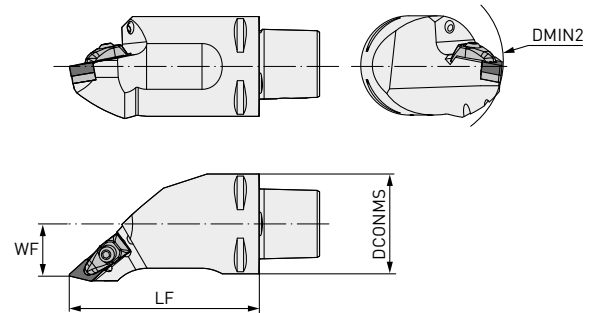



GAMF: -5°
GAMP: -9°



Codice ordinazione	Disponibilità	Direzione	DCONMS	DMIN1	DMIN2	WF	LF	WT	Inserto
PSC63-DDMNL33120-15	●	L	63	63	130	33	120	2.30	DN \odot 1506 $\odot\odot$
PSC63-DDMNR33120-15	●	R							

RICAMBI

Codice utensile						
PSC63-DDMNL33120-15	MP1766	MPIDSN-432	MP2712	MP1696	MP4295	MP5004
PSC63-DDMNR33120-15						

DSDN 45°



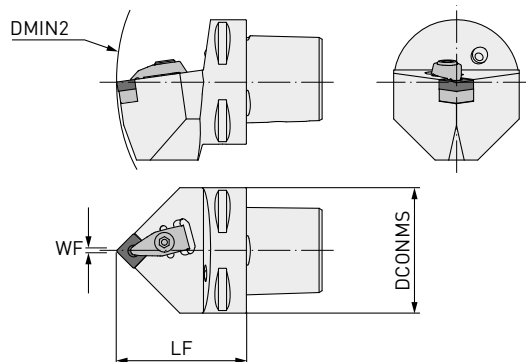
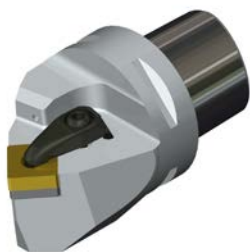



PORTAUTENSILE PER TORNITURA E SMUSSATURA ESTERNA
EQUIPAGGIATO CON INSERTI BILATERALI NEGATIVI A FORMA QUADRATA



GAMF: -6°
GAMP: -6°

Codice ordinazione	Disponibilità	DCONMS	DMIN2	WF	LF	WT	Inserto
PSC40-DSDNN00050-12	●	40	140	0.3	50	0.35	
PSC50-DSDNN00060-12	●	50	165	0.3	60	0.75	SN00120400
PSC63-DSDNN00065-12	●	63	190	0.3	65	1.07	
PSC50-DSDNN00065-19	●	50	170	0.5	65	0.80	
PSC63-DSDNN00070-19	●	63	195	0.5	70	1.26	SN00190600

RICAMBI

Codice utensile						
PSC40-DSDNN00050-12	MP1766	MPISSN-442	MP2712			
PSC50-DSDNN00060-12	MP1766	MPISSN-442	MP2712			
PSC63-DSDNN00065-12	MP1766	MPISSN-442	MP2712	MP1696	MP4295	MP5004
PSC50-DSDNN00065-19	MP1770	MPISSN-633	MP2719			
PSC63-DSDNN00070-19	MP1770	MPISSN-633	MP2719			

DSSN 45°

PORTAUTENSILE PER TORNITURA E SMUSSATURA ESTERNA
EQUIPAGGIATO CON INSERTI BILATERALI NEGATIVI A FORMA QUADRATA





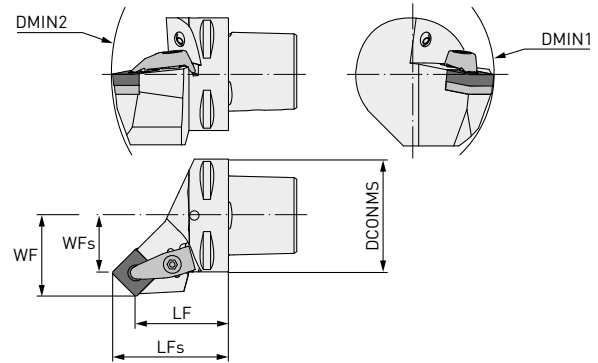



GAMF: -8°
GAMP: 0°



Codice ordinazione	Disponibilità	Direzione	DCONMS	DMIN1	DMIN2	WF	WFs	LF	LFs	WT	Inserto
PSC40-DSSNL27042-12	●	L	40	110	140	27	18.7	42	50.3	0.35	SN \odot 1204 $\odot\odot$
PSC40-DSSNR27042-12	●	R	40	110	140	27	18.7	42	50.3	0.35	
PSC50-DSSNL35052-12	●	L	50	110	165	35	26.7	52	60.3	0.70	
PSC50-DSSNR35052-12	●	R	50	110	165	35	26.7	52	60.3	0.70	
PSC63-DSSNL45056-12	●	L	63	110	190	45	36.7	56	64.3	1.12	
PSC63-DSSNR45056-12	●	R	63	110	190	45	36.7	56	64.3	1.12	

RICAMBI

Codice utensile						
PSC40-DSSNL27042-12						
PSC40-DSSNR27042-12						
PSC50-DSSNL35052-12	MP1766	MPISSN-442	MP2712	MP1696	MP4295	MP5004
PSC50-DSSNR35052-12						
PSC63-DSSNL45056-12						
PSC63-DSSNR45056-12						

DVJN 93°

PORTAUTENSILE PER OPERAZIONI ESTREMAMENTE SPECIFICHE
CON INSERTI BILATERALI NEGATIVI A FORMA ROMBICA





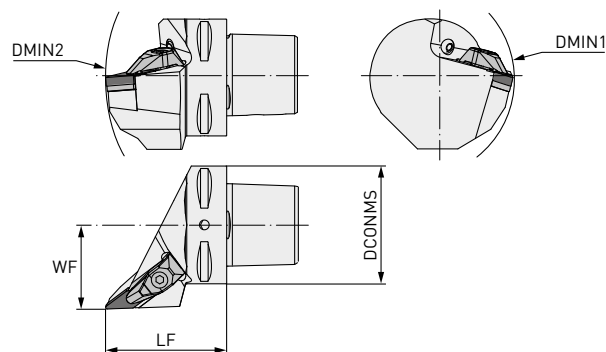



GAMF: -4°
GAMP: -13°



Codice ordinazione	Disponibilità	Direzione	DCONMS	DMIN1	DMIN2	WF	LF	WT	Inserto
PSC40-DVJNL27062-16	●	L	40	60	152	27	62	0.45	VN ⁰⁰ 1604 ⁰⁰
PSC40-DVJNR27062-16	●	R	40	60	152	27	62	0.45	
PSC50-DVJNL35065-16	●	L	50	65	170	35	65	0.79	
PSC50-DVJNR35065-16	□	R	50	65	170	35	65	0.79	
PSC63-DVJNL45065-16	●	L	63	81	190	45	65	1.10	
PSC63-DVJNR45065-16	●	R	63	81	190	45	65	1.10	
PSC80-DVJNL55080-16	●	L	80	100	250	55	80	2.74	
PSC80-DVJNR55080-16	●	R	80	100	250	55	80	2.74	

RICAMBI

Codice utensile						
PSC40-DVJNL27062-16						
PSC40-DVJNR27062-16						
PSC50-DVJNL35065-16						
PSC50-DVJNR35065-16	MP1764	MPIVSN-322	MP2708	MP1695	MP4294	MP5004
PSC63-DVJNL45065-16						
PSC63-DVJNR45065-16						
PSC80-DVJNL55080-16						
PSC80-DVJNR55080-16						

DVNN 72° 30'

PORTAUTENSILE PER PROFILATURA EQUIPAGGIATO CON INSERTI BILATERALI NEGATIVI A FORMA ROMBICA





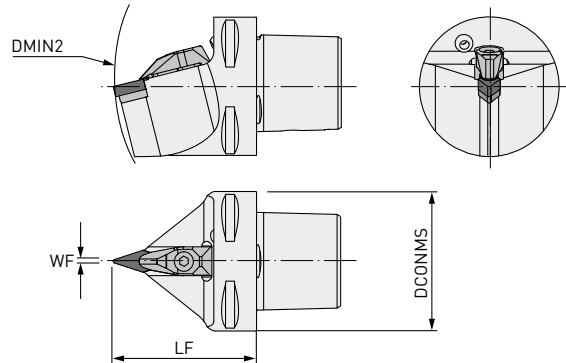



GAMF: -4°
GAMP: -13°



Codice ordinazione	Disponibilità	DCON	DMIN2	WF	LF	WT	Inserto
PSC40-DVNN00062-16	<input type="checkbox"/>	40	152	0.6	62	0.43	VN \odot 1604 \odot
PSC50-DVNN00065-16	<input type="checkbox"/>	50	170	0.6	65	0.80	
PSC63-DVNN00065-16	<input type="checkbox"/>	63	190	0.6	65	1.07	
PSC80-DVNN00080-16	<input type="checkbox"/>	80	250	0.6	80	2.32	

RICAMBI

Codice utensile						
PSC40-DVNN00062-16						
PSC50-DVNN00065-16	MP1764	MPIVSN-322	MP2708	MP1695	MP4294	MP5004
PSC63-DVNN00065-16						
PSC80-DVNN00080-16						

DWLN 95°

PORTAUTENSILI MULTI-FUNZIONE CON INSERTI TRIGONALI NEGATIVI





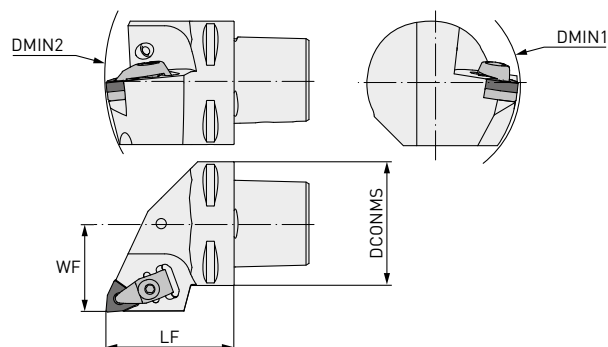



GAMF: -6°
GAMP: -6°



Codice ordinazione	Disponibilità	Direzione	DCONMS	DMIN1	DMIN2	WF	LF	WT	Inserto
PSC40-DWLN27050-06	●	L	40	60	140	27	50	0.42	WN00060400
PSC40-DWLN27050-06	●	R	40	60	140	27	50	0.42	
PSC50-DWLN35060-06	●	L	50	65	165	35	60	0.80	
PSC50-DWLN35060-06	●	R	50	65	165	35	60	0.80	
PSC40-DWLN27050-08	●	L	40	110	140	27	50	0.42	WN00080400
PSC40-DWLN27050-08	●	R	40	110	140	27	50	0.42	
PSC50-DWLN35060-08	●	L	50	110	165	35	60	0.80	
PSC50-DWLN35060-08	●	R	50	110	165	35	60	0.80	
PSC63-DWLN45065-08	●	L	63	110	190	45	65	1.10	
PSC63-DWLN45065-08	●	R	63	110	190	45	65	1.10	
PSC80-DWLN55080-08	●	L	80	110	250	55	80	2.74	
PSC80-DWLN55080-08	●	R	80	110	250	55	80	2.74	

RICAMBI

Codice utensile						
PSC40-DWLN27050-06	MP1764	MPIWSN-322	MP2708	MP1695	MP4294	MP5004
PSC40-DWLN27050-06	MP1764	MPIWSN-322	MP2708	MP1695	MP4294	
PSC50-DWLN35060-06	MP1764	MPIWSN-322	MP2708	MP1695	MP4294	
PSC50-DWLN35060-06	MP1764	MPIWSN-322	MP2708	MP1695	MP4294	
PSC40-DWLN27050-08	MP1766	MPIWSN-433	MP2712	MP1696	MP4295	
PSC40-DWLN27050-08	MP1766	MPIWSN-433	MP2712	MP1696	MP4295	
PSC50-DWLN35060-08	MP1766	MPIWSN-433	MP2712	MP1696	MP4295	
PSC50-DWLN35060-08	MP1766	MPIWSN-433	MP2712	MP1696	MP4295	
PSC63-DWLN45065-08	MP1766	MPIWSN-433	MP2712	MP1696	MP4295	
PSC63-DWLN45065-08	MP1766	MPIWSN-433	MP2712	MP1696	MP4295	
PSC80-DWLN55080-08	MP1766	MPIWSN-433	MP2712	MP1696	MP4295	
PSC80-DWLN55080-08	MP1766	MPIWSN-433	MP2712	MP1696	MP4295	

PCLN 95°

PORTAUTENSILE MULTIFUNZIONALE EQUIPAGGIATO CON INSERTI BILATERALI NEGATIVI A FORMA ROMBICA





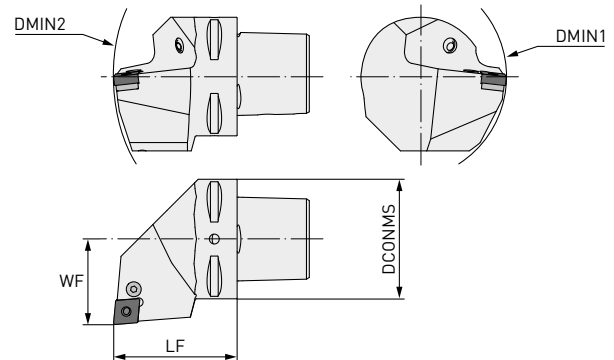

GAMF: -6°
GAMP: -6°



Codice ordinazione	Disponibilità	Direzione	DCON	DMIN1	DMIN2	WF	LF	WT	Inserto
PSC40-PCLNL27050-12	●	L	40	110	140	27	50	0.42	
PSC40-PCLNR27050-12	●	R	40	110	140	27	50	0.42	
PSC50-PCLNL35060-12	●	L	50	110	165	35	60	0.80	
PSC50-PCLNR35060-12	●	R	50	110	165	35	60	0.80	
PSC63-PCLNL45065-12	●	L	63	110	190	45	65	1.10	CN00120400
PSC63-PCLNR45065-12	●	R	63	110	190	45	65	1.10	
PSC80-PCLNL55080-12	●	L	80	110	250	55	80	2.74	
PSC80-PCLNR55080-12	●	R	80	110	250	55	80	2.74	
PSC50-PCLNL35060-16	●	L	50	125	165	35	60	0.80	
PSC50-PCLNR35060-16	●	R	50	125	165	35	60	0.80	
PSC63-PCLNL45065-16	●	L	63	125	190	45	65	1.10	CN00160600
PSC63-PCLNR45065-16	●	R	63	125	190	45	65	1.10	
PSC80-PCLNL55080-16	●	L	80	125	250	55	80	2.74	
PSC80-PCLNR55080-16	●	R	80	125	250	55	80	2.74	
PSC63-PCLNL45065-19	●	L	63	125	190	45	65	1.10	CN00190600
PSC63-PCLNR45065-19	●	R	63	125	190	45	65	1.10	
PSC80-PCLNL55080-19	●	L	80	125	250	55	80	2.74	
PSC80-PCLNR55080-19	●	R	80	125	250	55	80	2.74	

RICAMBI

Codice utensile					
PSC40-PCLNL27050-12	MP8012	MP1608	MP5003	MP3612	MP4112
PSC40-PCLNR27050-12	MP8012	MP1608	MP5003	MP3612	MP4112
PSC50-PCLNL35060-12	MP8012	MP1608	MP5003	MP3612	MP4112
PSC50-PCLNR35060-12	MP8012	MP1608	MP5003	MP3612	MP4112
PSC63-PCLNL45065-12	MP8012	MP1608	MP5003	MP3612	MP4112
PSC63-PCLNR45065-12	MP8012	MP1608	MP5003	MP3612	MP4112
PSC80-PCLNL55080-12	MP8012	MP1608	MP5003	MP3612	MP4112
PSC80-PCLNR55080-12	MP8012	MP1608	MP5003	MP3612	MP4112
PSC50-PCLNL35060-16	MP8016	MP1618	MP5003	MP3616	MP4115
PSC50-PCLNR35060-16	MP8016	MP1618	MP5003	MP3616	MP4115
PSC63-PCLNL45065-16	MP8016	MP1618	MP5003	MP3616	MP4115
PSC63-PCLNR45065-16	MP8016	MP1618	MP5003	MP3616	MP4115
PSC80-PCLNL55080-16	MP8016	MP1618	MP5003	MP3616	MP4115
PSC80-PCLNR55080-16	MP8016	MP1618	MP5003	MP3616	MP4115
PSC63-PCLNL45065-19	MP8019	MP1610	MP5004	MP3619	MP4119
PSC63-PCLNR45065-19	MP8019	MP1610	MP5004	MP3619	MP4119
PSC80-PCLNL55080-19	MP8019	MP1610	MP5004	MP3619	MP4119
PSC80-PCLNR55080-19	MP8019	MP1610	MP5004	MP3619	MP4119

PCRN 75°

PORTAUTENSILE MULTIFUNZIONALE EQUIPAGGIATO CON INSERTI BILATERALI NEGATIVI A FORMA ROMBICA





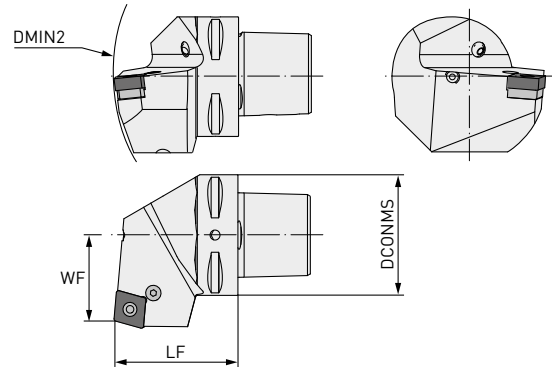

GAMF: -6°
GAMP: -6°



Codice ordinazione	Disponibilità	Direzione	DCONMS	DMIN2	WF	LF	WT	Inserto
PSC63-PCRNL35065-16	●	L	63	190	35	65	1.40	CN00160600
PSC63-PCRNR35065-16	●	R						
PSC63-PCRNL35065-19	●	L						CN00190600
PSC63-PCRNR35065-19	●	R						

RICAMBI

Codice utensile					
PSC63-PCRNL35065-16	MP8016	MP1618	MP5003	MP3616	MP4115
PSC63-PCRNR35065-16	MP8016	MP1618	MP5003	MP3616	MP4115
PSC63-PCRNL35065-19	MP8019	MP1610	MP5004	MP3619	MP4119
PSC63-PCRNR35065-19	MP8019	MP1610	MP5004	MP3619	MP4119

PDJN 93°

PORTAUTENSILE PER TORNITURA E PROFILATURA EQUIPAGGIATO CON INSERTI BILATERALI NEGATIVI A FORMA ROMBICA





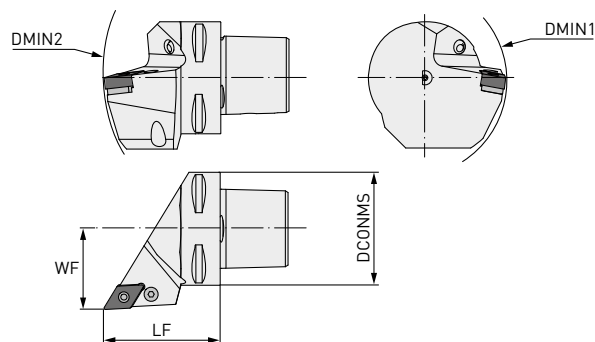

GAMF: -6°
GAMP: -7°



Codice ordinazione	Disponibilità	Direzione	DCONMS	DMIN1	DMIN2	WF	LF	WT	Inserto
PSC40-PDJNL27055-15	●	L	40	110	145	27	55	0.43	DN \odot 1506 \odot
PSC40-PDJNR27055-15	●	R	40	110	145	27	55	0.43	
PSC50-PDJNL35060-15	●	L	50	110	165	35	60	0.80	
PSC50-PDJNR35060-15	●	R	50	110	165	35	60	0.80	
PSC63-PDJNL45065-15	□	L	63	110	190	45	65	1.10	
PSC63-PDJNR45065-15	●	R	63	110	190	45	65	1.10	
PSC80-PDJNL55080-15	●	L	80	110	250	55	80	2.74	
PSC80-PDJNR55080-15	●	R	80	110	250	55	80	2.74	

RICAMBI

Codice utensile					
PSC40-PDJNL27055-15					
PSC40-PDJNR27055-15					
PSC50-PDJNL35060-15					
PSC50-PDJNR35060-15	MP8415	MP1638	MP5003	MP3715	MP4112
PSC63-PDJNL45065-15					
PSC63-PDJNR45065-15					
PSC80-PDJNL55080-15					
PSC80-PDJNR55080-15					

PSDN 45°

PORTAUTENSILE PER TORNITURA E SMUSSATURA ESTERNA
EQUIPAGGIATO CON INSERTI BILATERALI NEGATIVI A FORMA QUADRATA





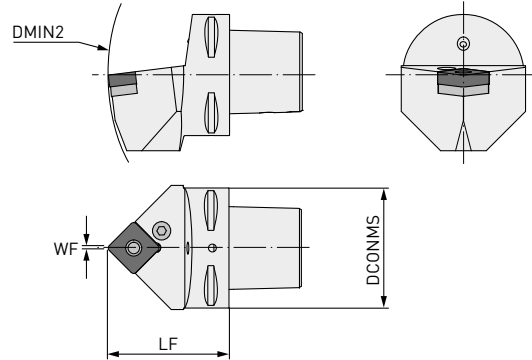

GAMF: -6°
GAMP: -6°



Codice ordinazione	Disponibilità	DCON	DMIN2	WF	LF	WT	Inserto
PSC63-PSDNN00065-12	<input type="checkbox"/>	63	190	0.3	65	1.07	SN00120400
PSC63-PSDNN00065-15	<input type="checkbox"/>	63	190	0.5	65	1.07	SN00150600
PSC63-PSDNN00065-19	<input type="checkbox"/>	63	195	0.5	65	1.07	SN00190600

RICAMBI

Codice utensile					
PSC63-PSDNN00065-12	MP8012	MP1608	MP5003	MP3512	MP4112
PSC63-PSDNN00065-15	MP8016	MP1618	MP5003	MP3515	MP4115
PSC63-PSDNN00065-19	MP8019	MP1610	MP5004	MP3519	MP4119

PSKN 75°

PORTAUTENSILE PER SFACCIATURA EQUIPAGGIATO CON INSERTI BILATERALI NEGATIVI A FORMA QUADRATA





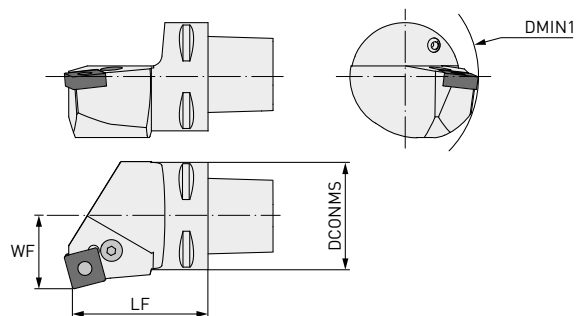

GAMF: -6°
GAMP: -6°



Codice ordinazione	Disponibilità	Direzione	DCONMS	DMIN1	WF	LF	WT	Inserto
PSC63-PSKNL45065-12	●	L	63	110	45	65	1.10	SN○○1204○○
PSC63-PSKNR45065-12	●	R	63	110	45	65	1.10	
PSC63-PSKNL45065-19	□	L	63	125	45	65	1.10	
PSC63-PSKNR45065-19	□	R	63	125	45	65	1.10	SN○○1906○○
PSC80-PSKNL55080-19	□	L	80	125	55	80	2.74	
PSC80-PSKNR55080-19	□	R	80	125	55	80	2.74	
PSC80-PSKNL55080-25	□	L	80	150	55	80	2.74	
PSC80-PSKNR55080-25	□	R	80	150	55	80	2.74	SN○○2507○○

RICAMBI

Codice utensile					
PSC63-PSKNL45065-12	MP8012	MP1608	MP5003	MP3512	MP4112
PSC63-PSKNR45065-12	MP8012	MP1608	MP5003	MP3512	MP4112
PSC63-PSKNL45065-19	MP8019	MP1610	MP5004	MP3519	MP4119
PSC63-PSKNR45065-19	MP8019	MP1610	MP5004	MP3519	MP4119
PSC80-PSKNL55080-19	MP8019	MP1610	MP5004	MP3519	MP4119
PSC80-PSKNR55080-19	MP8019	MP1610	MP5004	MP3519	MP4119
PSC80-PSKNL55080-25	MP8025	MP1612	MP5005	MP3525	MP4125
PSC80-PSKNR55080-25	MP8025	MP1612	MP5005	MP3525	MP4125

PSRN 75°

PORTAUTENSILE PER SFACCIATURA EQUIPAGGIATO CON INSERTI BILATERALI NEGATIVI A FORMA QUADRATA





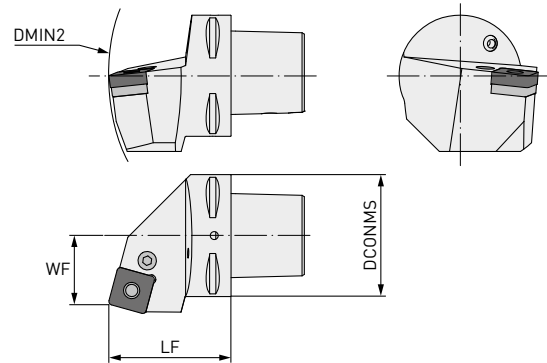

GAMF: -6°
GAMP: -6°



Codice ordinazione	Disponibilità	Direzione	DCONMS	DMIN2	WF	LF	WT	Inserto
PSC63-PSRNL35065-19	<input type="checkbox"/>	L	63	190	35	65	1.40	SN \odot 1906 \odot
PSC63-PSRNR35065-19	<input type="checkbox"/>	R	63	190	35	65	1.40	
PSC80-PSRNL45080-19	<input type="checkbox"/>	L	80	250	45	80	2.80	
PSC80-PSRNR45080-19	<input type="checkbox"/>	R	80	250	45	80	2.80	

RICAMBI

Codice utensile					
PSC63-PSRNL35065-19					
PSC63-PSRNR35065-19	MP8019	MP1610	MP5004	MP3519	MP4119
PSC80-PSRNL45080-19					
PSC80-PSRNR45080-19					

PSSN 45°

PORTAUTENSILE PER TORNITURA E SMUSSATURA ESTERNA
EQUIPAGGIATO CON INSERTI BILATERALI NEGATIVI A FORMA QUADRATA





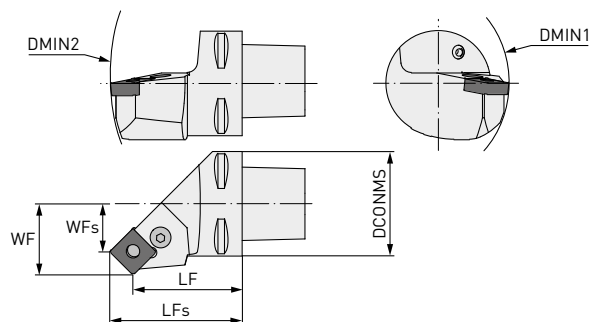

GAMF: -8°
GAMP: 0°



Codice ordinazione	Disponibilità	Direzione	DCONMS	DMIN1	DMIN2	WF	WFs	LF	LFs	WT	Inserto
PSC63-PSSNL45052-19	●	L	63	125	190	45	32.5	52	64.5	1.13	SN□□1906□□
PSC63-PSSNR45052-19	●	R									

RICAMBI

Codice utensile					
PSC63-PSSNL45052-19	MP8019	MP1610	MP5004	MP3519	MP4119
PSC63-PSSNR45052-19					

SCLC 95°

PORTAUTENSILE MULTIFUNZIONALE EQUIPAGGIATO CON INSERTI POSITIVI A FORMA ROMBICA





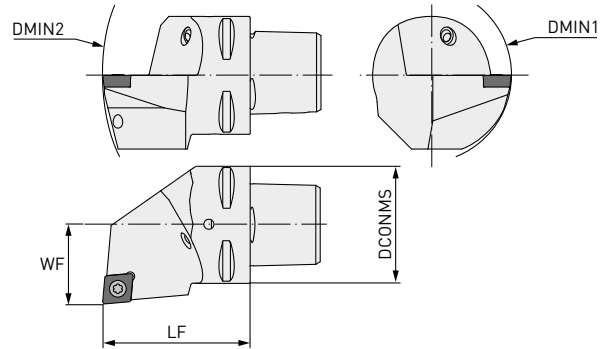

GAMF: 0°
GAMP: 0°



Codice ordinazione	Disponibilità	Direzione	DCONMS	DMIN1	DMIN2	WF	LF	WT	Inserto
PSC40-SCLCL27050-09	●	L	40	80	140	27	50	0.42	CC0009T300
PSC40-SCLCR27050-09	●	R	40	80	140	27	50	0.42	
PSC50-SCLCL35060-09	●	L	50	80	165	35	60	0.80	
PSC50-SCLCR35060-09	●	R	50	80	165	35	60	0.80	
PSC40-SCLCL27050-12	●	L	40	110	140	27	50	0.42	CC00120400
PSC40-SCLCR27050-12	●	R	40	110	140	27	50	0.42	
PSC50-SCLCL35060-12	●	L	50	110	165	35	60	0.80	
PSC50-SCLCR35060-12	●	R	50	110	165	35	60	0.80	
PSC63-SCLCL45065-12	●	L	63	110	190	45	65	1.10	
PSC63-SCLCR45065-12	●	R	63	110	190	45	65	1.10	

RICAMBI

Codice utensile				
PSC40-SCLCL27050-09	MP1240	MP5515		
PSC40-SCLCR27050-09	MP1240	MP5515		
PSC50-SCLCL35060-09	MP1240	MP5515		
PSC50-SCLCR35060-09	MP1240	MP5515		
PSC40-SCLCL27050-12	MP1540	MP5517		
PSC40-SCLCR27050-12	MP1540	MP5517		
PSC50-SCLCL35060-12	MP1540	MP5517		
PSC50-SCLCR35060-12	MP1540	MP5517	MP3614	MP1760
PSC63-SCLCL45065-12	MP1540	MP5517		
PSC63-SCLCR45065-12	MP1540	MP5517		

SDJC 93°

PORTAUTENSILE MULTIFUNZIONALE EQUIPAGGIATO CON INSERTI POSITIVI A FORMA ROMBICA





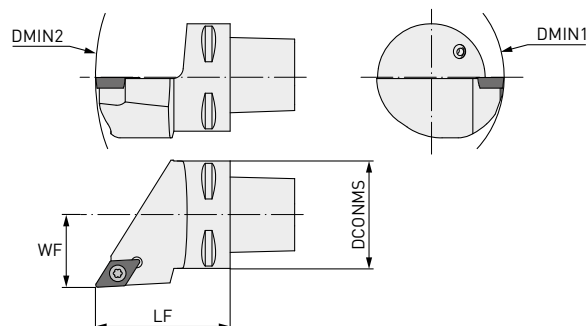

GAMF: 0°
GAMP: 0°



Codice ordinazione	Disponibilità	Direzione	DCONMS	DMIN1	DMIN2	WF	LF	WT	Inserto
PSC40-SDJCL27050-11	●	L	40	110	140	27	50	0.42	
PSC40-SDJCR27050-11	●	R	40	110	140	27	50	0.42	
PSC50-SDJCL35060-11	●	L	50	110	165	35	60	0.80	DC○○11T3○○
PSC50-SDJCR35060-11	●	R	50	110	165	35	60	0.80	
PSC63-SDJCL45065-11	●	L	63	110	190	45	65	1.10	
PSC63-SDJCR45065-11	●	R	63	110	190	45	65	1.10	

RICAMBI

Codice utensile				
PSC40-SDJCL27050-11				
PSC40-SDJCR27050-11				
PSC50-SDJCL35060-11	MP1335	MP5516	MP3714	MP1750
PSC50-SDJCR35060-11				
PSC63-SDJCL45065-11				
PSC63-SDJCR45065-11				

SDNC 62° 30'

PORTAUTENSILE MULTIFUNZIONALE PER PROFILATURA
EQUIPAGGIATO CON INSERTI POSITIVI A FORMA ROMBICA





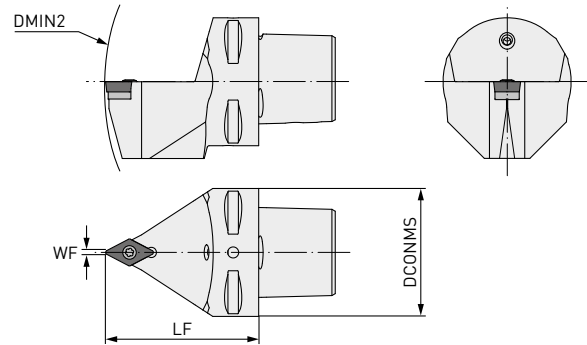

GAMF: 0°
GAMP: 0°



Codice ordinazione	Disponibilità	DCON	DMIN2	WF	LF	WT	Inserto
PSC40-SDNCN00050-11	●	40	140	0.5	50	0.35	DC0011T300
PSC50-SDNCN00060-11	●	50	165	0.5	60	0.75	

RICAMBI

Codice utensile				
PSC40-SDNCN00050-11	MP1335	MP5516	MP3714	MP1750
PSC50-SDNCN00060-11				

SVHC 107° 30`

PORTAUTENSILE MULTIFUNZIONALE PER PROFILATURA EQUIPAGGIATO CON INSERTI POSITIVI A FORMA ROMBICA





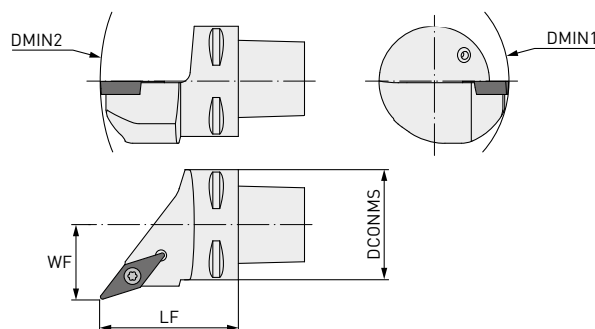

GAMF: 0°
GAMP: 0°



Codice ordinazione	Disponibilità	Direzione	DCONMS	DMIN1	DMIN2	WF	LF	WT	Inserto
PSC40-SVHCL27050-11	●	L	40	80	140	27	50	0.42	VC $\odot\odot$ 1103 $\odot\odot$
PSC40-SVHCR27050-11	●	R	40	80	140	27	50	0.42	
PSC40-SVHCL27050-16	●	L	40	110	140	27	50	0.42	
PSC40-SVHCR27050-16	●	R	40	110	140	27	50	0.42	
PSC50-SVHCL35060-16	●	L	50	110	165	35	60	0.80	VC $\odot\odot$ 1604 $\odot\odot$
PSC50-SVHCR35060-16	●	R	50	110	165	35	60	0.80	
PSC63-SVHCL45065-16	●	L	63	110	190	45	65	1.10	
PSC63-SVHCR45065-16	●	R	63	110	190	45	65	1.10	

RICAMBI

Codice utensile				
PSC40-SVHCL27050-11	MP1225	MP5507		
PSC40-SVHCR27050-11	MP1225	MP5507		
PSC40-SVHCL27050-16	MP1335	MP5516		
PSC40-SVHCR27050-16	MP1335	MP5516		
PSC50-SVHCL35060-16	MP1335	MP5516		
PSC50-SVHCR35060-16	MP1335	MP5516	MP3718	MP1750
PSC63-SVHCL45065-16	MP1335	MP5516		
PSC63-SVHCR45065-16	MP1335	MP5516		

SVJC 93°

PORTAUTENSILE MULTIFUNZIONALE PER PROFILATURA EQUIPAGGIATO CON INSERTI POSITIVI A FORMA ROMBICA





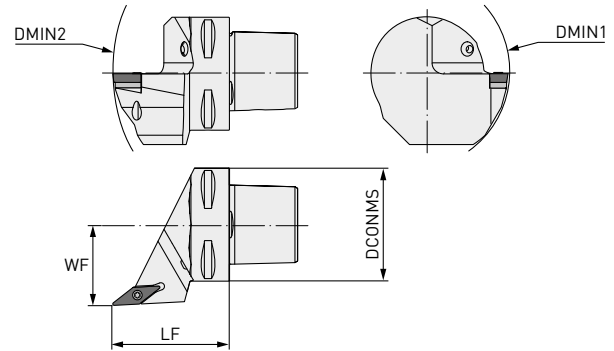

GAMF: 0°
GAMP: 0°



Codice ordinazione	Disponibilità	Direzione	DCON	DMIN1	DMIN2	WF	LF	WT	Inserto
PSC40-SVJCL27050-11	●	L	40	80	145	27	50	0.42	VC00110300
PSC40-SVJCR27050-11	●	R	40	80	145	27	50	0.42	
PSC40-SVJCL27050-16	●	L	40	110	145	27	50	0.42	
PSC40-SVJCR27050-16	●	R	40	110	145	27	50	0.42	
PSC50-SVJCL35060-16	●	L	50	110	165	35	60	0.80	VC00160400
PSC50-SVJCR35060-16	●	R	50	110	165	35	60	0.80	
PSC63-SVJCL45065-16	●	L	63	110	190	45	65	1.10	
PSC63-SVJCR45065-16	●	R	63	110	190	45	65	1.10	

RICAMBI

Codice utensile				
PSC40-SVJCL27050-11	MP1225	MP5507		
PSC40-SVJCR27050-11	MP1225	MP5507		
PSC40-SVJCL27050-16	MP1335	MP5516	MP3718	MP1750
PSC40-SVJCR27050-16	MP1335	MP5516	MP3718	MP1750
PSC50-SVJCL35060-16	MP1335	MP5516	MP3718	MP1750
PSC50-SVJCR35060-16	MP1335	MP5516	MP3718	MP1750
PSC63-SVJCL45065-16	MP1335	MP5516	MP3718	MP1750
PSC63-SVJCR45065-16	MP1335	MP5516	MP3718	MP1750

SVVC 72° 30`

PORTAUTENSILE MULTIFUNZIONALE PER PROFILATURA EQUIPAGGIATO CON INSERTI POSITIVI A FORMA ROMBICA





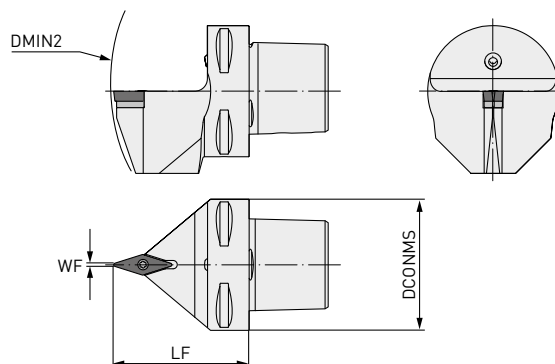

GAMF: 0°
GAMP: 0°



Codice ordinazione	Disponibilità	DCONMS	DMIN2	WF	LF	WT	Inserto
PSC40-SVVCN00050-11	<input type="checkbox"/>	40	140	0.3	50	0.35	VC00110300
PSC40-SVVCN00050-16	<input type="checkbox"/>	40	140	0.6	50	0.35	
PSC50-SVVCN00060-16	<input type="checkbox"/>	50	165	0.6	60	0.75	VC00160400
PSC63-SVVCN00065-16	<input type="checkbox"/>	63	190	0.6	65	1.07	

RICAMBI

Codice utensile				
PSC40-SVVCN00050-11	MP1225	MP5507		
PSC40-SVVCN00050-16	MP1335	MP5516	MP3718	MP1750
PSC50-SVVCN00060-16	MP1335	MP5516	MP3718	MP1750
PSC63-SVVCN00065-16	MP1335	MP5516	MP3718	MP1750

PCLN 95°

UTENSILE PER TORNITURA INTERNA EQUIPAGGIATO CON INSERTI BILATERALI NEGATIVI A FORMA ROMBICA





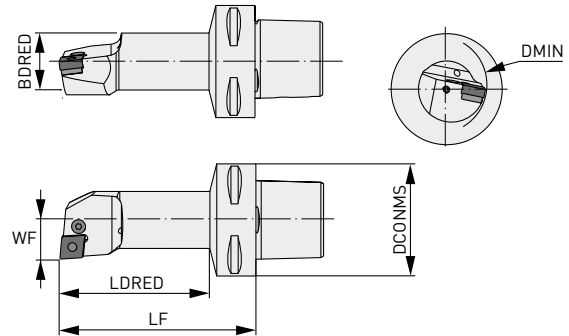

GAMF: -6°



Codice ordinazione	Disponibilità	Direzione	DCONMS	DMIN	BORED	WF	LF	LDRED	GAMF	WT	Inserto
PSC40-PCLNL13080-09	●	L	40	25	20	13	80	58	-11°	0.40	CN00090300
PSC40-PCLNR13080-09	●	R	40	25	20	13	80	58	-11°	0.40	
PSC50-PCLNL13080-09	●	L	50	25	20	13	80	56	-11°	0.57	
PSC50-PCLNR13080-09	●	R	50	25	20	13	80	56	-11°	0.57	
PSC40-PCLNL17090-12	●	L	40	32	25	17	90	69	-11°	0.48	CN00120400
PSC40-PCLNR17090-12	●	R	40	32	25	17	90	69	-11°	0.48	
PSC40-PCLNL22110-12	●	L	40	40	32	22	110	89	-11°	0.75	
PSC40-PCLNR22110-12	●	R	40	40	32	22	110	89	-11°	0.75	
PSC40-PCLNL27120-12	●	L	40	50	40	27	120	100	-11°	1.13	CN00160600
PSC40-PCLNR27120-12	●	R	40	50	40	27	120	100	-11°	1.13	
PSC50-PCLNL17090-12	●	L	50	32	25	17	90	67	-11°	0.70	CN00160600
PSC50-PCLNR17090-12	●	R	50	32	25	17	90	67	-11°	0.70	
PSC50-PCLNL22110-12	●	L	50	40	32	22	110	88	-11°	0.93	
PSC50-PCLNR22110-12	●	R	50	40	32	22	110	88	-11°	0.93	
PSC50-PCLNL27140-12	●	L	50	50	40	27	140	119	-10°	1.47	CN00160600
PSC50-PCLNR27140-12	●	R	50	50	40	27	140	119	-10°	1.47	
PSC50-PCLNL35100-12	●	L	50	63	50	35	100	81	-7°	1.48	CN00160600
PSC50-PCLNR35100-12	●	R	50	63	50	35	100	81	-7°	1.48	
PSC63-PCLNL17100-12	●	L	63	32	25	17	100	74	-11°	1	CN00160600
PSC63-PCLNR17100-12	●	R	63	32	25	17	100	74	-11°	1	
PSC63-PCLNL22110-12	●	L	63	40	32	22	110	84	-11°	1.26	
PSC63-PCLNR22110-12	●	R	63	40	32	22	110	84	-11°	1.26	
PSC50-PCLNL35150-16	●	L	50	63	50	35	150	131	-11°	2.25	CN00160600
PSC50-PCLNR35150-16	●	R	50	63	50	35	150	131	-11°	2.25	
PSC63-PCLNL27140-16	●	L	63	50	40	27	140	115	-11°	1.78	
PSC63-PCLNR27140-16	●	R	63	50	40	27	140	115	-11°	1.78	
PSC63-PCLNL35175-16	●	L	63	63	50	35	175	152	-11°	2.85	CN00160600
PSC63-PCLNR35175-16	●	R	63	63	50	35	175	152	-11°	2.85	

RICAMBI

Codice utensile					
PSC40-PCLNL13080-09	MP8005	MP1605	MP5002		
PSC40-PCLNR13080-09	MP8005	MP1605	MP5002		
PSC50-PCLNL13080-09	MP8005	MP1605	MP5002		
PSC50-PCLNR13080-09	MP8005	MP1605	MP5002		
PSC40-PCLNL17090-12	MP8212	MP1626	MP5025		
PSC40-PCLNR17090-12	MP8212	MP1626	MP5025		
PSC40-PCLNL22110-12	MP8312	MP1648	MP5003	MP3612	MP4112
PSC40-PCLNR22110-12	MP8312	MP1648	MP5003	MP3612	MP4112
PSC40-PCLNL27120-12	MP8012	MP1608	MP5003	MP3612	MP4112
PSC40-PCLNR27120-12	MP8012	MP1608	MP5003	MP3612	MP4112
PSC50-PCLNL17090-12	MP8212	MP1626	MP5025		
PSC50-PCLNR17090-12	MP8212	MP1626	MP5025		
PSC50-PCLNL22110-12	MP8312	MP1648	MP5003	MP3612	MP4112
PSC50-PCLNR22110-12	MP8312	MP1648	MP5003	MP3612	MP4112
PSC50-PCLNL27140-12	MP8012	MP1608	MP5003	MP3612	MP4112
PSC50-PCLNR27140-12	MP8012	MP1608	MP5003	MP3612	MP4112
PSC50-PCLNL35100-12	MP8012	MP1608	MP5003	MP3612	MP4112
PSC50-PCLNR35100-12	MP8012	MP1608	MP5003	MP3612	MP4112
PSC63-PCLNL17100-12	MP8212	MP1626	MP5025		
PSC63-PCLNR17100-12	MP8212	MP1626	MP5025		
PSC63-PCLNL22110-12	MP8312	MP1648	MP5003	MP3612	MP4112
PSC63-PCLNR22110-12	MP8312	MP1648	MP5003	MP3612	MP4112
PSC50-PCLNL35150-16	MP8016	MP1618	MP5003	MP3616	MP4115
PSC50-PCLNR35150-16	MP8016	MP1618	MP5003	MP3616	MP4115
PSC63-PCLNL27140-16	MP8016	MP1618	MP5003	MP3616	MP4115
PSC63-PCLNR27140-16	MP8016	MP1618	MP5003	MP3616	MP4115
PSC63-PCLNL35175-16	MP8016	MP1618	MP5003	MP3616	MP4115
PSC63-PCLNR35175-16	MP8016	MP1618	MP5003	MP3616	MP4115

PDUN 93°



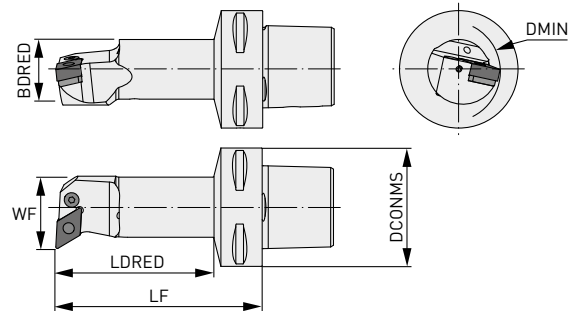

UTENSILE PER TORNITURA INTERNA E PROFILATURA CON INSERTI BILATERALI NEGATIVI A FORMA ROMBICA



GAMF: -6°

Codice ordinazione	Disponibilità	Direzione	DCONMS	DMIN	BDRED	WF	LF	LDRED	GAMF	WT	Inserto
PSC40-PDUNL17090-11	●	L	40	32	25	17	90	69	-11°	0.48	DN \odot 1104 $\odot\odot$
PSC40-PDUNR17090-11	●	R	40	32	25	17	90	69	-11°	0.48	
PSC40-PDUNL22110-11	●	L	40	40	32	22	110	89	-10°	0.75	
PSC40-PDUNR22110-11	●	R	40	40	32	22	110	89	-10°	0.75	
PSC50-PDUNL17090-11	●	L	50	32	25	17	90	67	-11°	0.70	
PSC50-PDUNR17090-11	●	R	50	32	25	17	90	67	-11°	0.70	
PSC50-PDUNL22110-11	●	L	50	40	32	22	110	88	-10°	0.93	
PSC50-PDUNR22110-11	●	R	50	40	32	22	110	88	-10°	0.93	
PSC63-PDUNL17100-11	●	L	63	32	25	17	100	74	-11°	1	
PSC63-PDUNR17100-11	●	R	63	32	25	17	100	74	-11°	1	
PSC40-PDUNL27080-15	●	L	40	50	40	27	80	60	-11°	0.74	
PSC40-PDUNR27080-15	●	R	40	50	40	27	80	60	-11°	0.74	
PSC40-PDUNL27120-15	●	L	40	50	40	27	120	100	-11°	1.13	
PSC40-PDUNR27120-15	●	R	40	50	40	27	120	100	-11°	1.13	
PSC50-PDUNL27140-15	●	L	50	50	40	27	140	119	-11°	1.47	DN \odot 1506 $\odot\odot$
PSC50-PDUNR27140-15	●	R	50	50	40	27	140	119	-11°	1.47	
PSC50-PDUNL35150-15	●	L	50	63	50	35	150	131	-10°	2.25	
PSC50-PDUNR35150-15	●	R	50	63	50	35	150	131	-10°	2.25	
PSC63-PDUNL22110-15	●	L	63	40	32	22	110	84	-12°	1.26	
PSC63-PDUNR22110-15	●	R	63	40	32	22	110	84	-12°	1.26	
PSC63-PDUNL27140-15	●	L	63	50	40	27	140	115	-11°	1.78	
PSC63-PDUNR27140-15	●	R	63	50	40	27	140	115	-11°	1.78	
PSC63-PDUNL35175-15	●	L	63	63	50	35	175	152	-10°	2.85	
PSC63-PDUNR35175-15	●	R	63	63	50	35	175	152	-10°	2.85	

RICAMBI

Codice utensile					
PSC40-PDUNL17090-11	MP8009	MP1606	MP5025	MP3711	MP4109
PSC40-PDUNR17090-11	MP8009	MP1606	MP5025	MP3711	MP4109
PSC40-PDUNL22110-11	MP8009	MP1606	MP5025	MP3711	MP4109
PSC40-PDUNR22110-11	MP8009	MP1606	MP5025	MP3711	MP4109
PSC50-PDUNL17090-11	MP8009	MP1606	MP5025	MP3711	MP4109
PSC50-PDUNR17090-11	MP8009	MP1606	MP5025	MP3711	MP4109
PSC50-PDUNL22110-11	MP8009	MP1606	MP5025	MP3711	MP4109
PSC50-PDUNR22110-11	MP8009	MP1606	MP5025	MP3711	MP4109
PSC63-PDUNL17100-11	MP8009	MP1606	MP5025	MP3711	MP4109
PSC63-PDUNR17100-11	MP8009	MP1606	MP5025	MP3711	MP4109
PSC40-PDUNL27080-15	MP8415	MP1638	MP5003	MP3715	MP4112
PSC40-PDUNR27080-15	MP8415	MP1638	MP5003	MP3715	MP4112
PSC40-PDUNL27120-15	MP8415	MP1638	MP5003	MP3715	MP4112
PSC40-PDUNR27120-15	MP8415	MP1638	MP5003	MP3715	MP4112
PSC50-PDUNL27140-15	MP8415	MP1638	MP5003	MP3715	MP4112
PSC50-PDUNR27140-15	MP8415	MP1638	MP5003	MP3715	MP4112
PSC50-PDUNL35150-15	MP8415	MP1638	MP5003	MP3715	MP4112
PSC50-PDUNR35150-15	MP8415	MP1638	MP5003	MP3715	MP4112
PSC63-PDUNL22110-15	MP8415	MP1638	MP5003	MP3715	MP4112
PSC63-PDUNR22110-15	MP8415	MP1638	MP5003	MP3715	MP4112
PSC63-PDUNL27140-15	MP8415	MP1638	MP5003	MP3715	MP4112
PSC63-PDUNR27140-15	MP8415	MP1638	MP5003	MP3715	MP4112
PSC63-PDUNL35175-15	MP8415	MP1638	MP5003	MP3715	MP4112
PSC63-PDUNR35175-15	MP8415	MP1638	MP5003	MP3715	MP4112

SCLC 95°



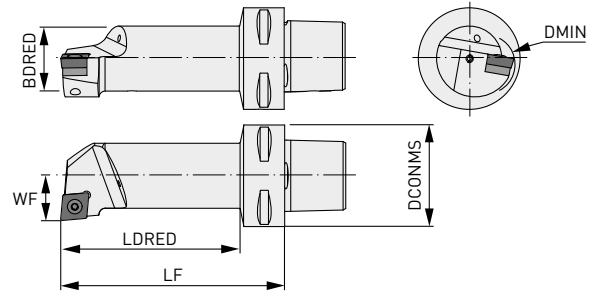

UTENSILE MULTIFUNZIONALE PER TORNITURA INTERNA EQUIPAGGIATO CON INSERTI POSITIVI A FORMA ROMBICA



GAMF: 0°

Codice ordinazione	Disponibilità	Direzione	DCONMS	DMIN	BORED	WF	LF	LDRED	GAMF	WT	Inserto
PSC40-SCLCL11070-09	●	L	40	20	16	11	70	47	-12°	0.33	CC0009T300
PSC40-SCLCR11070-09	●	R	40	20	16	11	70	47	-12°	0.33	
PSC40-SCLCL13080-09	●	L	40	25	20	13	80	58	-8°	0.40	
PSC40-SCLCR13080-09	●	R	40	25	20	13	80	58	-8°	0.40	
PSC40-SCLCL17090-09	●	L	40	32	25	17	90	69	-6°	0.48	
PSC40-SCLCR17090-09	●	R	40	32	25	17	90	69	-6°	0.48	
PSC50-SCLCL11070-09	●	L	50	20	16	11	70	46	-12°	0.50	
PSC50-SCLCR11070-09	●	R	50	20	16	11	70	46	-12°	0.50	
PSC50-SCLCL13080-09	●	L	50	25	20	13	80	56	-8°	0.57	
PSC50-SCLCR13080-09	●	R	50	25	20	13	80	56	-8°	0.57	
PSC50-SCLCL17090-09	●	L	50	32	25	17	90	67	-6°	0.70	
PSC50-SCLCR17090-09	●	R	50	32	25	17	90	67	-6°	0.70	
PSC50-SCLCL35100-09	●	L	50	63	49.7	35	100	81	-4°	1.48	
PSC50-SCLCR35100-09	●	R	50	63	49.7	35	100	81	-4°	1.48	
PSC40-SCLCL22110-12	●	L	40	40	32	22	110	89	-10°	0.75	CC00120400
PSC40-SCLCR22110-12	●	R	40	40	32	22	110	89	-10°	0.75	
PSC50-SCLCL22110-12	●	L	50	40	32	22	110	88	-10°	0.93	
PSC50-SCLCR22110-12	●	R	50	40	32	22	110	88	-10°	0.93	
PSC50-SCLCL27140-12	●	L	50	50	40	27	140	119	-8°	1.47	
PSC50-SCLCR27140-12	●	R	50	50	40	27	140	119	-8°	1.47	
PSC50-SCLCL35100-12	●	L	50	63	49.7	35	100	80	-5°	1.48	
PSC50-SCLCR35100-12	●	R	50	63	49.7	35	100	80	-5°	1.48	

RICAMBI

Codice utensile				
PSC40-SCLCL11070-09	MP1440	MP5515		
PSC40-SCLCR11070-09	MP1440	MP5515		
PSC40-SCLCL13080-09	MP1440	MP5515		
PSC40-SCLCR13080-09	MP1440	MP5515		
PSC40-SCLCL17090-09	MP1240	MP5515		
PSC40-SCLCR17090-09	MP1240	MP5515		
PSC50-SCLCL11070-09	MP1440	MP5515		
PSC50-SCLCR11070-09	MP1440	MP5515		
PSC50-SCLCL13080-09	MP1440	MP5515		
PSC50-SCLCR13080-09	MP1440	MP5515		
PSC50-SCLCL17090-09	MP1240	MP5515		
PSC50-SCLCR17090-09	MP1240	MP5515		
PSC50-SCLCL35100-09	MP1240	MP5515		
PSC50-SCLCR35100-09	MP1240	MP5515		
PSC40-SCLCL22110-12	MP1540	MP5517		
PSC40-SCLCR22110-12	MP1540	MP5517		
PSC50-SCLCL22110-12	MP1540	MP5517		
PSC50-SCLCL27140-12	MP1540	MP5517		
PSC50-SCLCL35100-12	MP1540	MP5517	MP3614	MP1760
PSC50-SCLCR22110-12	MP1540	MP5517		
PSC50-SCLCR27140-12	MP1540	MP5517		
PSC50-SCLCR35100-12	MP1540	MP5517		

SDUC 93°

UTENSILE MULTIFUNZIONALE PER TORNITURA INTERNA E
PROFILATURA EQUIPAGGIATO CON INSERTI POSITIVI A FORMA ROMBICA





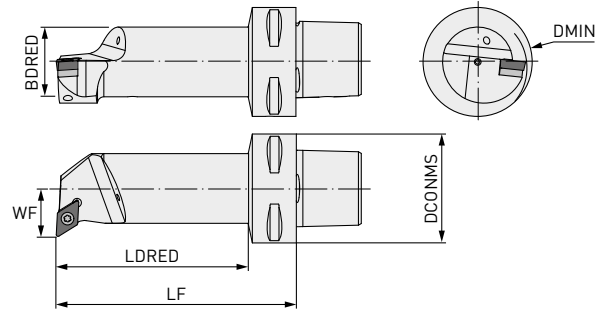

GAMF: 0°



Codice ordinazione	Disponibilità	Direzione	DCONMS	DMIN	BDRED	WF	LF	LDRED	GAMP	WT	Inserto
PSC40-SDUCL11070-07	●	L	40	20	16	11	70	47	-8°	0.33	DC00070200
PSC40-SDUCR11070-07	●	R	40	20	16	11	70	47	-8°	0.33	
PSC50-SDUCL11070-07	●	L	50	20	16	11	70	46	-8°	0.50	
PSC50-SDUCR11070-07	●	R	50	20	16	11	70	46	-8°	0.50	
PSC40-SDUCL13080-11	●	L	40	25	20	13	80	58	-6°	0.40	DC0011T300
PSC40-SDUCR13080-11	●	R	40	25	20	13	80	58	-6°	0.40	
PSC40-SDUCL17090-11	●	L	40	32	25	17	90	69	-6°	0.48	
PSC40-SDUCR17090-11	●	R	40	32	25	17	90	69	-6°	0.48	
PSC40-SDUCL22110-11	●	L	40	40	32	22	110	89	-6°	0.75	DC0011T300
PSC40-SDUCR22110-11	●	R	40	40	32	22	110	89	-6°	0.75	
PSC40-SDUCL27080-11	●	L	40	50	40	27	80	60	-6°	0.74	
PSC40-SDUCR27080-11	●	R	40	50	40	27	80	60	-6°	0.74	
PSC50-SDUCL13080-11	●	L	50	25	20	13	80	56	-6°	0.57	DC0011T300
PSC50-SDUCR13080-11	●	R	50	25	20	13	80	56	-6°	0.57	
PSC50-SDUCL17090-11	●	L	50	32	25	17	90	67	-6°	0.70	
PSC50-SDUCR17090-11	●	R	50	32	25	17	90	67	-6°	0.70	
PSC50-SDUCL22110-11	●	L	50	40	32	22	110	88	-6°	0.93	DC0011T300
PSC50-SDUCR22110-11	●	R	50	40	32	22	110	88	-6°	0.93	
PSC50-SDUCL35100-11	●	L	50	63	49.7	35	100	81	-4°	1.48	
PSC50-SDUCR35100-11	●	R	50	63	49.7	35	100	81	-4°	1.48	

RICAMBI

Codice utensile				
PSC40-SDUCL11070-07	MP1225	MP5507		
PSC40-SDUCR11070-07	MP1225	MP5507		
PSC50-SDUCL11070-07	MP1225	MP5507		
PSC50-SDUCR11070-07	MP1225	MP5507		
PSC40-SDUCL13080-11	MP1240	MP5515		
PSC40-SDUCR13080-11	MP1240	MP5515		
PSC40-SDUCL17090-11	MP1240	MP5515		
PSC40-SDUCR17090-11	MP1240	MP5515		
PSC40-SDUCL22110-11	MP1335	MP5516	MP3714	MP1750
PSC40-SDUCR22110-11	MP1335	MP5516	MP3714	MP1750
PSC40-SDUCL27080-11	MP1335	MP5516	MP3714	MP1750
PSC40-SDUCR27080-11	MP1335	MP5516	MP3714	MP1750
PSC50-SDUCL13080-11	MP1240	MP5515		
PSC50-SDUCR13080-11	MP1240	MP5515		
PSC50-SDUCL17090-11	MP1240	MP5515		
PSC50-SDUCR17090-11	MP1240	MP5515		
PSC50-SDUCL22110-11	MP1335	MP5516	MP3714	MP1750
PSC50-SDUCR22110-11	MP1335	MP5516	MP3714	MP1750
PSC50-SDUCL35100-11	MP1335	MP5516	MP3714	MP1750
PSC50-SDUCR35100-11	MP1335	MP5516	MP3714	MP1750

SVQC 107° 30`

UTENSILE MULTIFUNZIONALE PER TORNITURA INTERNA E
PROFILATURA EQUIPAGGIATO CON INSERTI POSITIVI A FORMA ROMBICA





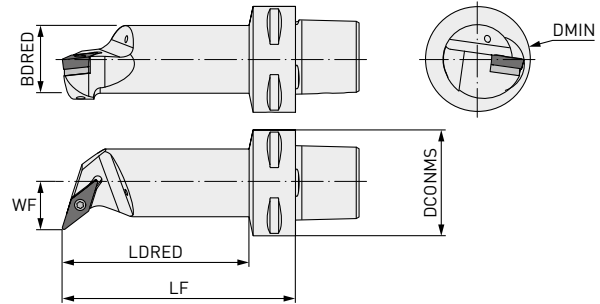

GAMF: 0°
GAMP: -8°



Codice ordinazione	Disponibilità	Direzione	DCONMS	DMIN	BDRED	WF	LF	LDRED	WT	Inserto
PSC63-SVQCL22120-16	●	L	63	40	32	22	120	94	1.28	VC \odot 1604 \odot
PSC63-SVQCR22120-16	●	R	63	40	32	22	120	94	1.28	
PSC63-SVQCL27145-16	●	L	63	50	40	27	145	120	1.78	
PSC63-SVQCR27145-16	●	R	63	50	40	27	145	120	1.78	
PSC63-SVQCL35175-16	●	L	63	63	50	35	175	152	2.85	
PSC63-SVQCR35175-16	●	R	63	63	50	35	175	152	2.85	

RICAMBI

Codice utensile				
PSC63-SVQCL22120-16				
PSC63-SVQCL27145-16				
PSC63-SVQCL35175-16	MP1335	MP5516	MP3718	MP1750
PSC63-SVQCR22120-16				
PSC63-SVQCR27145-16				
PSC63-SVQCR35175-16				



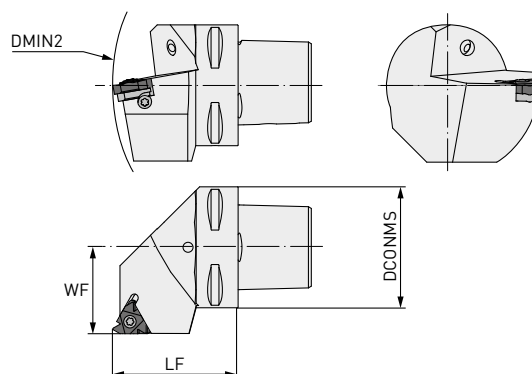

FILETTATURA ESTERNA 90°

PORTAUTENSILE MULTIFUNZIONALE PER FILETTATURA ESTERNA CON INSERTI NEGATIVI



Codice ordinazione	Disponibilità	Direzione	DCONMS	DMIN2	WF	LF	WT	Inserto
PSC40-SEL27050-16	☐	L	40	140	27	50	0.42	MMT16E ^{○○}
PSC40-SER27050-16	●	R	40	140	27	50	0.42	
PSC50-SEL35060-16	☐	L	50	165	35	60	0.80	
PSC50-SER35060-16	●	R	50	165	35	60	0.80	
PSC63-SEL45065-16	☐	L	63	190	45	65	1.10	
PSC63-SER45065-16	●	R	63	190	45	65	1.10	
PSC40-SEL27050-22	☐	L	40	140	27	50	0.42	MMT22E ^{○○}
PSC40-SER27050-22	●	R	40	140	27	50	0.42	
PSC50-SEL35060-22	☐	L	50	165	35	60	0.80	
PSC50-SER35060-22	●	R	50	165	35	60	0.80	
PSC63-SEL45065-22	☐	L	63	190	45	65	1.10	
PSC63-SER45065-22	●	R	63	190	45	65	1.10	

RICAMBI

Codice utensile					
PSC40-SEL27050-16	MPSA3	MP5510	MPYI3	MPYE3	MPSY3
PSC40-SER27050-16	MPSA3	MP5510	MPYI3	MPYE3	MPSY3
PSC50-SEL35060-16	MPSA3	MP5510	MPYI3	MPYE3	MPSY3
PSC50-SER35060-16	MPSA3	MP5510	MPYI3	MPYE3	MPSY3
PSC63-SEL45065-16	MPSA3	MP5510	MPYI3	MPYE3	MPSY3
PSC63-SER45065-16	MPSA3	MP5510	MPYI3	MPYE3	MPSY3
PSC40-SEL27050-22	MPSA4	MP5520	MPYI4	MPYE4	MPSY4
PSC40-SER27050-22	MPSA4	MP5520	MPYI4	MPYE4	MPSY4
PSC50-SEL35060-22	MPSA4	MP5520	MPYI4	MPYE4	MPSY4
PSC50-SER35060-22	MPSA4	MP5520	MPYI4	MPYE4	MPSY4
PSC63-SEL45065-22	MPSA4	MP5520	MPYI4	MPYE4	MPSY4
PSC63-SER45065-22	MPSA4	MP5520	MPYI4	MPYE4	MPSY4

FILETTATURA INTERNA 90°

UTENSILE MULTIFUNZIONALE PER FILETTATURA INTERNA CON INSERTI NEGATIVI

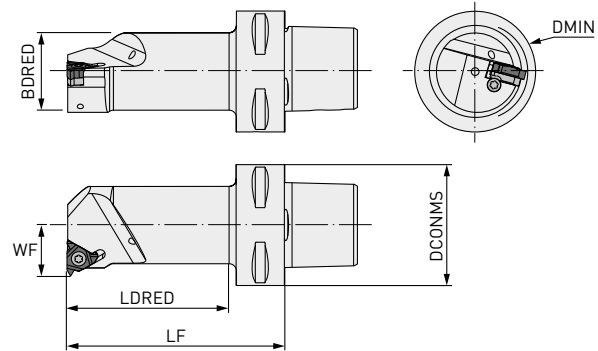





Codice ordinazione	Disponibilità	Direzione	DCONMS	DMIN	WF	LF	BDRED	LDRED	WT	Inserto
PSC40-SIL12060-16	□	L	40	20	12	60	15.5	37	0.30	MMT16 \odot
PSC40-SIR12060-16	●	R	40	20	12	60	15.5	37	0.30	
PSC40-SIL14060-16	□	L	40	25	14	60	18.5	38	0.34	
PSC40-SIR14060-16	●	R	40	25	14	60	18.5	38	0.34	
PSC40-SIL17070-16	□	L	40	32	17	70	24.5	48	0.41	
PSC40-SIR17070-16	●	R	40	32	17	70	24.5	48	0.41	
PSC40-SIL22090-16	□	L	40	40	22	90	32	69	0.65	
PSC40-SIR22090-16	●	R	40	40	22	90	35	69	0.65	
PSC40-SIL27080-16	□	L	40	50	27	80	39.5	60	0.76	
PSC40-SIR27080-16	●	R	40	50	27	80	39.5	60	0.76	
PSC50-SIL12060-16	□	L	50	20	12	60	15.5	35	0.49	
PSC50-SIR12060-16	●	R	50	20	12	60	15.5	35	0.49	
PSC50-SIL14060-16	□	L	50	25	14	60	18.5	36	0.51	
PSC50-SIR14060-16	●	R	50	25	14	60	18.5	36	0.51	
PSC50-SIL17070-16	□	L	50	32	17	70	24.5	47	0.59	
PSC50-SIR17070-16	●	R	50	32	17	70	24.5	47	0.59	
PSC50-SIL22090-16	□	L	50	40	22	90	24.5	68	0.82	
PSC50-SIR22090-16	●	R	50	40	22	90	24.5	68	0.82	
PSC50-SIL27105-16	□	L	50	50	27	105	40	84	1.20	
PSC50-SIR27105-16	●	R	50	50	27	105	40	84	1.20	
PSC63-SIL14070-16	□	L	63	25	14	70	18.5	42	0.90	
PSC63-SIR14070-16	●	R	63	25	14	70	18.5	42	0.90	
PSC63-SIL17075-16	□	L	63	32	17	75	24.5	48	0.97	
PSC63-SIR17075-16	●	R	63	32	17	75	24.5	48	0.97	
PSC63-SIL22090-16	□	L	63	40	22	90	32	64	1.14	
PSC63-SIR22090-16	●	R	63	40	22	90	32	64	1.14	
PSC63-SIL27105-16	□	L	63	50	27	105	40	80	1.20	
PSC63-SIR27105-16	●	R	63	50	27	105	40	80	1.20	
PSC40-SIL15065-22	□	L	40	25	15	65	18.5	42	0.35	
PSC40-SIR15065-22	●	R	40	25	15	65	18.5	42	0.35	
PSC40-SIL19070-22	□	L	40	32	19	70	25	48	0.42	
PSC40-SIR19070-22	●	R	40	32	19	70	25	48	0.42	





FILETTATURA INTERNA 90°

Codice ordinazione	Disponibilità	Direzione	DCONMS	DMIN	WF	LF	BDRED	LDRED	WT	Inserto
PSC40-SIL22090-22	☐	L	40	40	22	90	31.5	69	0.65	
PSC40-SIR22090-22	●	R	40	40	22	90	31.5	69	0.65	
PSC40-SIL27080-22	☐	L	40	50	27	80	39.5	60	0.76	
PSC40-SIR27080-22	●	R	40	50	27	80	39.5	60	0.76	
PSC50-SIL15065-22	☐	L	50	25	15	65	18.5	41	0.35	
PSC50-SIR15065-22	●	R	50	25	15	65	18.5	41	0.35	
PSC50-SIL19070-22	☐	L	50	32	19	70	25	48	0.60	
PSC50-SIR19070-22	●	R	50	32	19	70	25	48	0.60	
PSC50-SIL22090-22	☐	L	50	40	22	90	31.5	68	0.82	MMT22100
PSC50-SIR22090-22	●	R	50	40	22	90	31.5	68	0.82	
PSC50-SIL27105-22	☐	L	50	50	27	105	40	84	1.20	
PSC50-SIR27105-22	●	R	50	50	27	105	40	84	1.20	
PSC63-SIL19075-22	☐	L	63	32	19	75	25	48	0.97	
PSC63-SIR19075-22	●	R	63	32	19	75	25	48	0.97	
PSC63-SIL22090-22	☐	L	63	40	22	90	31.5	64	1.14	
PSC63-SIR22090-22	●	R	63	40	22	90	31.5	64	1.14	
PSC63-SIL27105-22	☐	L	63	50	27	105	40	80	1.50	
PSC63-SIR27105-22	●	R	63	50	27	105	40	80	1.50	

RICAMBI

Codice utensile					
PSC40-SIL12060-16	MPSN3	MP5510	—	—	
PSC40-SIR12060-16	MPSN3	MP5510	—	—	
PSC40-SIL14060-16	MPSA3T	MP5510	MPYE3	MPYI3	MPSY3
PSC40-SIR14060-16	MPSA3T	MP5510	MPYE3	MPYI3	MPSY3
PSC40-SIL17070-16	MPSA3	MP5510	MPYE3	MPYI3	MPSY3
PSC40-SIR17070-16	MPSA3	MP5510	MPYE3	MPYI3	MPSY3
PSC40-SIL22090-16	MPSA3	MP5510	MPYE3	MPYI3	MPSY3
PSC40-SIR22090-16	MPSA3	MP5510	MPYE3	MPYI3	MPSY3
PSC40-SIL27080-16	MPSA3	MP5510	MPYE3	MPYI3	MPSY3
PSC40-SIR27080-16	MPSA3	MP5510	MPYE3	MPYI3	MPSY3
PSC50-SIL12060-16	MPSN3	MP5510	—	—	
PSC50-SIR12060-16	MPSN3	MP5510	—	—	
PSC50-SIL14060-16	MPSA3T	MP5510	MPYE3	MPYI3	MPSY3
PSC50-SIR14060-16	MPSA3T	MP5510	MPYE3	MPYI3	MPSY3
PSC50-SIL17070-16	MPSA3	MP5510	MPYE3	MPYI3	MPSY3
PSC50-SIR17070-16	MPSA3	MP5510	MPYE3	MPYI3	MPSY3
PSC50-SIL22090-16	MPSA3	MP5510	MPYE3	MPYI3	MPSY3
PSC50-SIR22090-16	MPSA3	MP5510	MPYE3	MPYI3	MPSY3
PSC50-SIL27105-16	MPSA3	MP5510	MPYE3	MPYI3	MPSY3
PSC50-SIR27105-16	MPSA3	MP5510	MPYE3	MPYI3	MPSY3
PSC63-SIL14070-16	MPSA3T	MP5510	MPYE3	MPYI3	MPSY3
PSC63-SIR14070-16	MPSA3T	MP5510	MPYE3	MPYI3	MPSY3

RICAMBI

Codice utensile			 	
PSC63-SIL17075-16	MPSA3	MP5510	MPYE3	MPSY3
PSC63-SIR17075-16	MPSA3	MP5510	MPYI3	MPSY3
PSC63-SIL22090-16	MPSA3	MP5510	MPYE3	MPSY3
PSC63-SIR22090-16	MPSA3	MP5510	MPYI3	MPSY3
PSC63-SIL27105-16	MPSA3	MP5510	MPYE3	MPSY3
PSC63-SIR27105-16	MPSA3	MP5510	MPYI3	MPSY3
PSC40-SIL15065-22	MPSN4	MP5520	—	
PSC40-SIR15065-22	MPSN4	MP5520	—	
PSC40-SIL19070-22	MPSA4	MP5520	MPYE4	MPSY4
PSC40-SIR19070-22	MPSA4	MP5520	MPYI4	MPSY4
PSC40-SIL22090-22	MPSA4	MP5520	MPYE4	MPSY4
PSC40-SIR22090-22	MPSA4	MP5520	MPYI4	MPSY4
PSC40-SIL27080-22	MPSA4	MP5520	MPYE4	MPSY4
PSC40-SIR27080-22	MPSA4	MP5520	MPYI4	MPSY4
PSC50-SIL15065-22	MPSN4	MP5520	—	
PSC50-SIR15065-22	MPSN4	MP5520	—	
PSC50-SIL19070-22	MPSA4	MP5520	MPYE4	MPSY4
PSC50-SIR19070-22	MPSA4	MP5520	MPYI4	MPSY4
PSC50-SIL22090-22	MPSA4	MP5520	MPYE4	MPSY4
PSC50-SIR22090-22	MPSA4	MP5520	MPYI4	MPSY4
PSC50-SIL27105-22	MPSA4	MP5520	MPYE4	MPSY4
PSC50-SIR27105-22	MPSA4	MP5520	MPYI4	MPSY4
PSC63-SIL19075-22	MPSA4	MP5520	MPYE4	MPSY4
PSC63-SIR19075-22	MPSA4	MP5520	MPYI4	MPSY4
PSC63-SIL22090-22	MPSA4	MP5520	MPYE4	MPSY4
PSC63-SIR22090-22	MPSA4	MP5520	MPYI4	MPSY4
PSC63-SIL27105-22	MPSA4	MP5520	MPYE4	MPSY4
PSC63-SIR27105-22	MPSA4	MP5520	MPYI4	MPSY4

FILETTATURA

SCHEMA DI UTILIZZO

ESECUZIONE FILETTATURA DESTRA

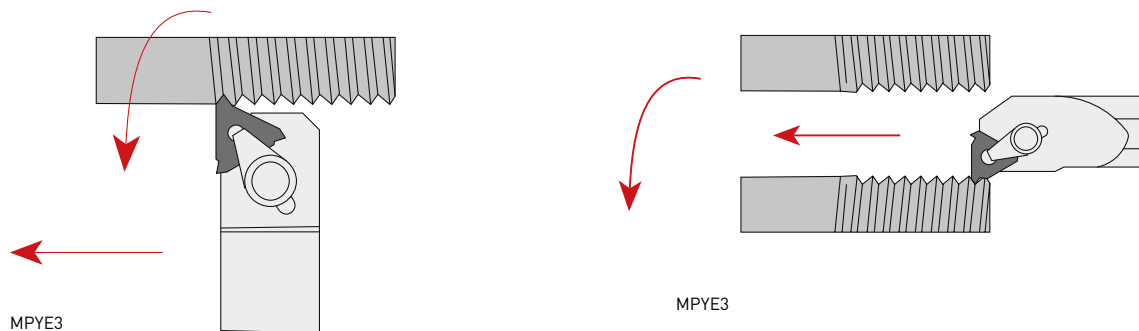

ESECUZIONE FILETTATURA SINISTRA

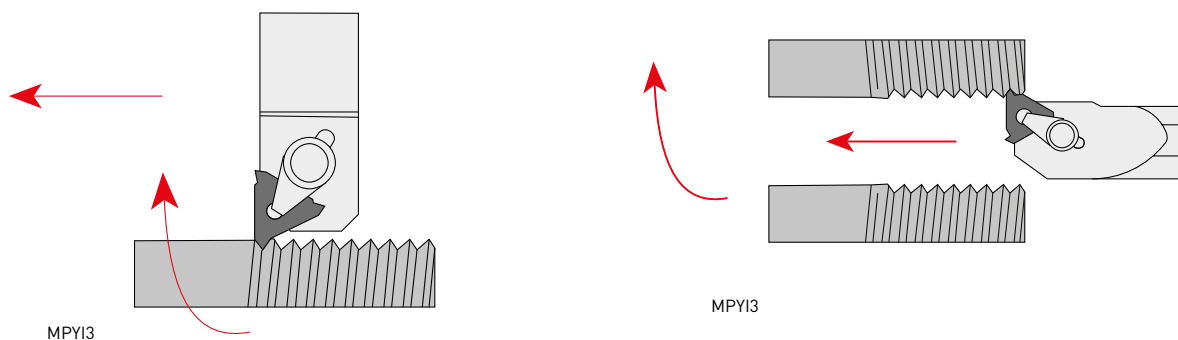

SCELTA DEL SOTTOPLACCHETTA PER OTTENERE LA CORRETTA SPOGLIA DELL'ELICA

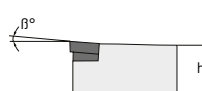
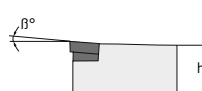
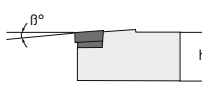
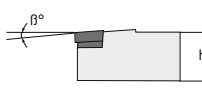
Dimensione inserto	+3°	+2°	+1°	0°	
MMT16E	MP3424P3	MP3424P2	MP3424P1	MPYE3	
MMT16I	MP3425P3	MP3425P2	MP3425P1	MPYI3	
Dimensione inserto	-3°	-2°	-1°	0°	
MMT16E	MP3424M3	MP3424M2	MP3424M1	MPYE3	
MMT16I	MP3425M3	MP3425M2	MP3425M1	MPYI3	

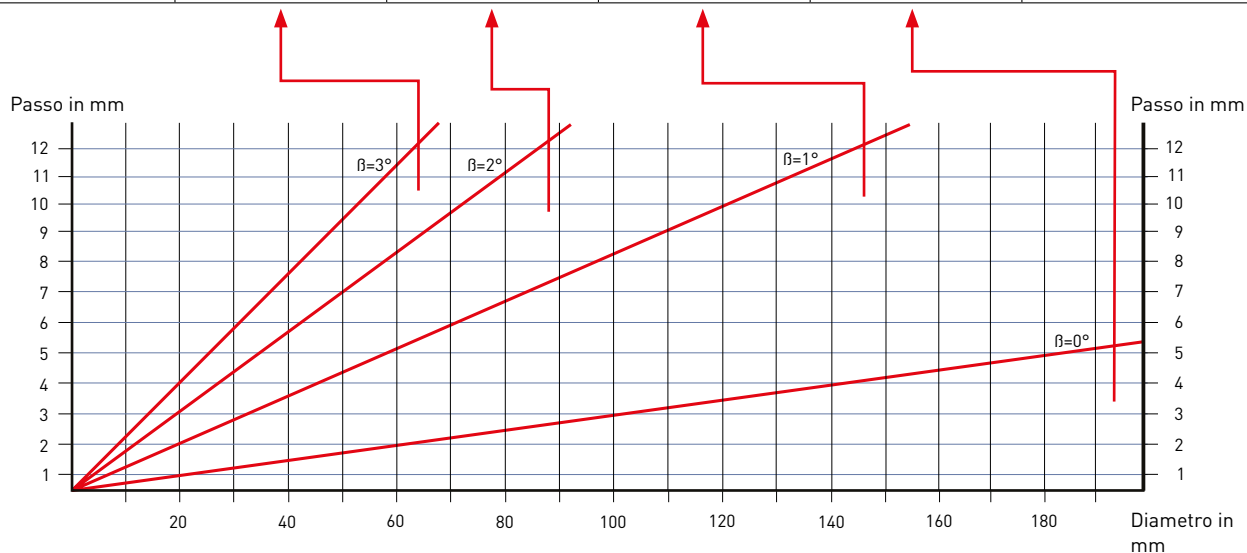

CRSN

PORTAUTENSILE MULTIFUNZIONALE PER TORNITURA E PER PROFILATURA EQUIPAGGIATO CON INSERTI BILATERALI NEGATIVI ROTONDI



GAMF: -6°
GAMP: -6°

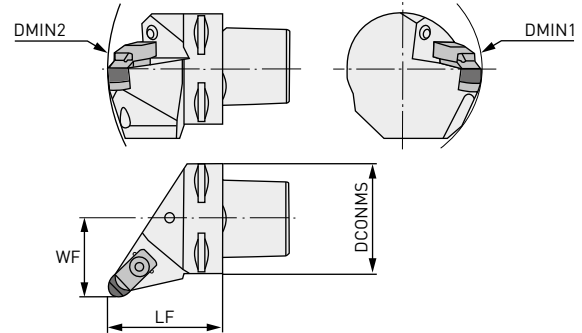

Codice ordinazione	Disponibilità	Direzione	DCONMS	DMIN1	DMIN2	LF	WF	WT	Inserto
PSC40-CRSNL27050-124	●	L	40	110	140	50	27	0.42	RNGN1204 $\odot\odot$
PSC40-CRSNR27050-124	●	R	40	110	140	50	27	0.42	
PSC50-CRSNL35060-124	●	L	50	110	165	60	35	0.80	
PSC50-CRSNR35060-124	●	R	50	110	165	60	35	0.80	
PSC63-CRSNL45065-124	●	L	63	110	190	65	45	1.10	
PSC63-CRSNR45065-124	●	R	63	110	190	65	45	1.10	
PSC40-CRSNL27050-127	●	L	40	110	140	50	27	0.42	RNGN1207 $\odot\odot$
PSC40-CRSNR27050-127	●	R	40	110	140	50	27	0.42	
PSC50-CRSNL35060-127	●	L	50	110	165	60	35	0.80	
PSC50-CRSNR35060-127	●	R	50	110	165	60	35	0.80	
PSC63-CRSNL45065-127	●	L	63	110	190	65	45	1.10	
PSC63-CRSNR45065-127	●	R	63	110	190	65	45	1.10	

RICAMBI

Codice utensile							
PSC40-CRSNL27050-124	MPIRSN44						
PSC40-CRSNR27050-124	MPIRSN44						
PSC50-CRSNL35060-124	MPIRSN44						
PSC50-CRSNR35060-124	MPIRSN44						
PSC63-CRSNL45065-124	MPIRSN44						
PSC63-CRSNR45065-124	MPIRSN44						
PSC40-CRSNL27050-127	MPIRSN42	MP1766	MP9414	MP2713	MP1086	MP5004	
PSC40-CRSNR27050-127	MPIRSN42						
PSC50-CRSNL35060-127	MPIRSN42						
PSC50-CRSNR35060-127	MPIRSN42						
PSC63-CRSNL45065-127	MPIRSN42						
PSC63-CRSNR45065-127	MPIRSN42						

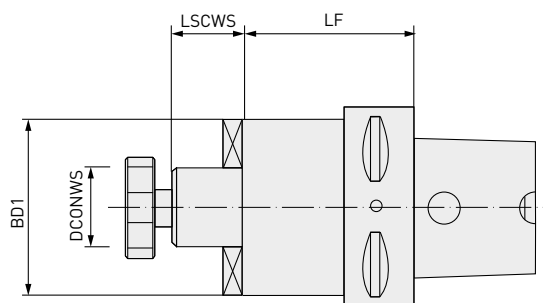

ADATTATORE ATTACCO TIPO MA (MANICOTTO)

ADATTATORE PER FRESE CON ATTACCO A MANICOTTO E TRASCINATORI SEC. DIN 138



Codice ordinazione	Disponibilità	PSC	DCONWS	LF	LSCWS	BD1
PSC63-MA-16063	●	63	16	63	17	37
PSC63-MA-22100	●	63	22	100	19	47
PSC63-MA-27100	●	63	27	100	21	58
PSC63-MA-32100	●	63	32	100	24	63

RICAMBI

Codice utensile			
PSC63-MA-16063	MP10008	MP86016	MP11103
PSC63-MA-22100	MP10010	MP86022	MP11004
PSC63-MA-27100	MP10012	MP86027	MP11005
PSC63-MA-32100	MP10016	MP86032	MP11005

ADATTATORE ATTACCO TIPO MS (AVVITATO METRICO)

ADATTATORE PER FRESE CON ATTACCO FILETTATO METRICO

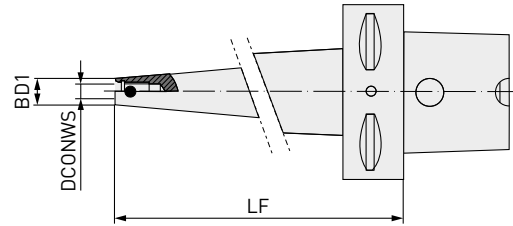

Codice ordinazione	Disponibilità	PSC	LF	DCONWS	BD1
PSC63-MS-10090	●	63	90	M10	18
PSC63-MS-12100	●	63	100	M12	21
PSC63-MS-16100	●	63	100	M16	29

ADATTATORE ATTACCO TIPO B (BARENO)

ADATTATORE PER BARENI CON ATTACCO CON PIANO/I (PSC ISO 26623-1)

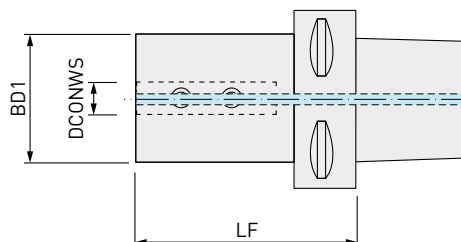

Codice ordinazione	Disponibilità	PSC	DCONWS	LF	BD1
PSC40-B-08050	●	50	08	50	44
PSC40-B-10050	●	40	10	50	44
PSC40-B-12050	●	40	12	50	44
PSC40-B-16050	●	40	16	50	44
PSC40-B-20050	●	40	20	50	44
PSC40-B-25060	●	40	25	60	50
PSC50-B-08052	●	50	08	52	44
PSC50-B-10052	●	50	10	52	44
PSC50-B-12052	●	50	12	52	44
PSC50-B-16052	●	50	16	52	44
PSC50-B-20052	●	50	20	52	50
PSC50-B-25060	●	50	25	60	55
PSC63-B-08060	●	63	08	60	44
PSC63-B-10060	●	63	10	60	44
PSC63-B-12060	●	63	12	60	44
PSC63-B-16060	●	63	16	60	44
PSC63-B-20060	●	63	20	60	50
PSC63-B-25072	●	63	25	72	55
PSC63-B-32075	●	63	32	75	55
PSC63-B-40085	●	63	40	85	65
PSC80-B-16085	□	80	16	85	44
PSC80-B-20085	□	80	20	85	50
PSC80-B-25085	□	80	25	85	55
PSC80-B-32085	□	80	32	85	72
PSC80-B-40095	□	80	40	95	65
PSC80-B-50100	□	80	50	100	75

ADATTATORE ATTACCO TIPO B (BARENO)
RICAMBI
Codice utensile



PSC40-B-08050	MP14206
PSC40-B-10050	MP14208
PSC40-B-12050	MP14208
PSC40-B-16050	MP14210
PSC40-B-20050	MP14210
PSC40-B-25060	MP14210
PSC50-B-08052	MP14206
PSC50-B-10052	MP14208
PSC50-B-12052	MP14208
PSC50-B-16052	MP14210
PSC50-B-20052	MP14210
PSC50-B-25060	MP14210
PSC63-B-08060	MP14206
PSC63-B-10060	MP14208
PSC63-B-12060	MP14208
PSC63-B-16060	MP14210
PSC63-B-20060	MP14210
PSC63-B-25072	MP14210
PSC63-B-32075	MP14210
PSC63-B-40085	MP14210
PSC80-B-16085	MP14210
PSC80-B-20085	MP14210
PSC80-B-25085	MP14210
PSC80-B-32085	MP17110
PSC80-B-40095	MP14210
PSC80-B-50100	MP14210

ADATTATORE ATTACCO TIPO C (PORTA PINZA ERC)

PORTA PINZA A NORMA DIN 6499 (ERC)

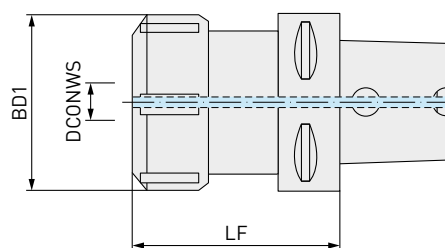

PINZE PER UTENSILI CON ATTACCO CILINDRICO

A NORMA DIN1835-A



Codice ordinazione	Disponibilità	PSC	LF	DCONWS	BD1
PSC40-C-16060	<input type="checkbox"/>	40	60	0.5-10	28
PSC40-C-20060	<input type="checkbox"/>	40	60	1-13	34
PSC40-C-25060	<input type="checkbox"/>	40	60	1-16	42
PSC40-C-32060	<input type="checkbox"/>	40	60	2-20	50
PSC50-C-16060	<input type="checkbox"/>	50	60	0.5-10	28
PSC50-C-16100	<input type="checkbox"/>	50	100	0.5-10	28
PSC50-C-20060	<input type="checkbox"/>	50	60	1-13	34
PSC50-C-20100	<input type="checkbox"/>	50	100	1-13	34
PSC50-C-25060	<input type="checkbox"/>	50	60	1-16	42
PSC50-C-25100	<input type="checkbox"/>	50	100	1-16	42
PSC50-C-32060	<input type="checkbox"/>	50	60	2-20	50
PSC50-C-32100	<input type="checkbox"/>	50	100	2-20	50
PSC50-C-40060	<input type="checkbox"/>	50	65	3-30	63
PSC50-C-40100	<input type="checkbox"/>	50	100	3-30	63
PSC63-C-16060	<input type="checkbox"/>	63	60	0.5-10	28
PSC63-C-16100	<input type="checkbox"/>	63	100	0.5-10	28
PSC63-C-20060	<input type="checkbox"/>	63	60	1-13	34
PSC63-C-20100	<input type="checkbox"/>	63	100	1-13	34
PSC63-C-25060	<input type="checkbox"/>	63	60	1-16	42
PSC63-C-25100	<input type="checkbox"/>	63	100	1-16	42
PSC63-C-32060	<input type="checkbox"/>	63	60	2-20	50
PSC63-C-32100	<input type="checkbox"/>	63	100	2-20	50
PSC63-C-40070	<input type="checkbox"/>	63	70	3-30	63
PSC63-C-40120	<input type="checkbox"/>	63	120	3-30	63
PSC80-C-32070	<input type="checkbox"/>	80	70	2-20	50
PSC80-C-32160	<input type="checkbox"/>	80	160	2-20	50
PSC80-C-40070	<input type="checkbox"/>	80	70	3-30	63
PSC80-C-40160	<input type="checkbox"/>	80	160	3-30	63

ADATTATORE ATTACCO TIPO C (PORTA PINZA ERC)
RICAMBI

Codice utensile			
PSC40-C-16060	MPERC16●●	MP45316	MP50216
PSC40-C-20060	MPERC20●●	MP45320	MP50220
PSC40-C-25060	MPERC25●●	MP45325	MP50225
PSC40-C-32060	MPERC32●●	MP45332	MP50232
PSC50-C-16060	MPERC16●●	MP45316	MP50216
PSC50-C-16100	MPERC16●●	MP45316	MP50216
PSC50-C-20060	MPERC20●●	MP45320	MP50220
PSC50-C-20100	MPERC20●●	MP45320	MP50220
PSC50-C-25060	MPERC25●●	MP45325	MP50225
PSC50-C-25100	MPERC25●●	MP45325	MP50225
PSC50-C-32060	MPERC32●●	MP45332	MP50232
PSC50-C-32100	MPERC32●●	MP45332	MP50232
PSC50-C-40060	MPERC40●●	MP45340	MP50240
PSC50-C-40100	MPERC40●●	MP45340	MP50240
PSC63-C-16060	MPERC16●●	MP45316	MP50216
PSC63-C-16100	MPERC16●●	MP45316	MP50216
PSC63-C-20060	MPERC20●●	MP45320	MP50220
PSC63-C-20100	MPERC20●●	MP45320	MP50220
PSC63-C-25060	MPERC25●●	MP45325	MP50225
PSC63-C-25100	MPERC25●●	MP45325	MP50225
PSC63-C-32060	MPERC32●●	MP45332	MP50232
PSC63-C-32100	MPERC32●●	MP45332	MP50232
PSC63-C-40070	MPERC40●●	MP45340	MP50240
PSC63-C-40120	MPERC40●●	MP45340	MP50240
PSC80-C-32070	MPERC32●●	MP45332	MP50232
PSC80-C-32160	MPERC32●●	MP45332	MP50232
PSC80-C-40070	MPERC40●●	MP45340	MP50240
PSC80-C-40160	MPERC40●●	MP45340	MP50240

ADATTATORE TIPO TA (STELO QUADRO ASSIALE)

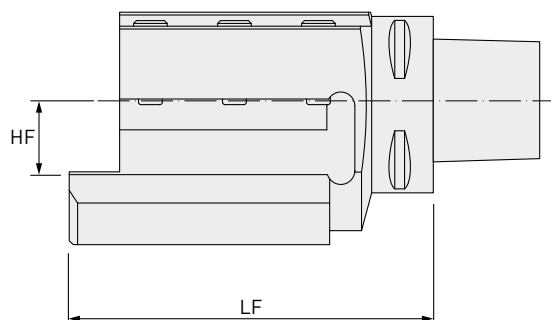

ADATTATORE PER ASSEMBLAGGIO ASSIALE

ADATTATORE PER STELO QUADRO DI TORNITURA DESTRO E SINISTRO



Codice ordinazione	Disponibilità	PSC	HF	LF
PSC50-TA-20098L	●	50	20	98
PSC50-TA-20098R	●	50	20	98
PSC63-TA-20100L	●	63	20	100
PSC63-TA-20100R	●	63	20	100
PSC63-TA-25130L	●	63	25	130
PSC63-TA-25130R	●	63	25	130
PSC63-TA-32134L	●	63	32	134
PSC63-TA-32134R	●	63	32	134
PSC80-TA-32140L	□	80	32	140
PSC80-TA-32140R	□	80	32	140

RICAMBI

Codice utensile	2x	
PSC50-TA-20098L	MP17010	 
PSC50-TA-20098R	MP17010	
PSC63-TA-20100L	MP17110	
PSC63-TA-20100R	MP17110	
PSC63-TA-25130L	MP17012	
PSC63-TA-25130R	MP17012	
PSC63-TA-32134L	MP17012	
PSC63-TA-32134R	MP17012	
PSC80-TA-32140L	MP17012	
PSC80-TA-32140R	MP17012	

MP29716

ADATTATORE TIPO TR (STELO QUADRO RADIALE)

ADATTATORE PER ASSEMBLAGGIO RADIALE

ADATTATORE UNIVERSALE PER STELO QUADRO DI TORNITURA

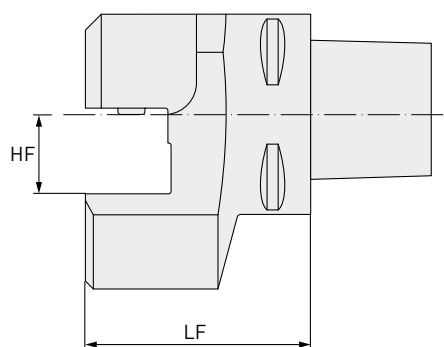

Codice ordinazione	Disponibilità	PSC	HF	LF
PSC50-TR-20058	●	50	20	58
PSC63-TR-25071	●	63	25	71
PSC63-TR-32071	●	63	32	71
PSC80-TR-32085	□	80	32	85

RICAMBI

Codice utensile



PSC50-TR-20058	MP17112	
PSC63-TR-25071	MP17012	
PSC63-TR-32071	MP17012	MP29716
PSC80-TR-32085	MP17012	

TAPPO PSC TIPO AC

TAPPO AUTOMATICO

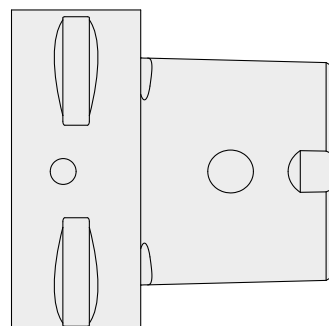

Codice ordinazione	Disponibilità	Tappo
PSC40-AC	●	40
PSC50-AC	●	50
PSC63-AC	●	63
PSC80-AC	●	80

**GERMANY**

MMC HARTMETALL GMBH
Comeniusstr. 2 . 40670 Meerbusch
Phone +49 2159 91890 . Fax +49 2159 918966
Email admin@mmchg.de

U.K.

MMC HARDMETAL U.K. LTD.
Mitsubishi House . Galena Close . Tamworth . Staffs. B77 4AS
Phone +44 1827 312312
Email sales@mitsubishicarbide.co.uk

SPAIN

MITSUBISHI MATERIALS ESPAÑA, S.A.
Calle Emperador 2 . 46136 Museros/Valencia
Phone +34 96 1441711 . Fax +34 96 1443786
Email comercial@mmevalencia.es

FRANCE

MMC METAL FRANCE S.A.R.L.
6, Rue Jacques Monod . 91400 Orsay
Phone +33 1 69 35 53 53 . Fax +33 1 69 35 53 50
Email mmfsales@mmc-metal-france.fr

POLAND

MMC HARDMETAL POLAND SP. Z O.O
Al. Armii Krajowej 61 . 50-541 Wrocław
Phone +48 71335 1620 . Fax +48 71335 1621
Email sales@mitsubishicarbide.com.pl

ITALY

MMC ITALIA S.R.L.
Viale Certosa 144 . 20156 Milano
Phone +39 0293 77031 . Fax +39 0293 589093
Email info@mmc-italia.it

TURKEY

MMC HARTMETALL GMBH ALMANYA - İZMİR MERKEZ ŞUBESİ
Adalet Mahallesi Anadolu Caddesi No: 41-1 . 15001 35530 Bayraklı/İzmir
Phone +90 232 5015000 . Fax +90 232 5015007
Email info@mmchg.com.tr

www.mmc-hardmetal.com

DISTRIBUITO DA:

┌

┐

└

┘